

Quiet-Duct® Silencers

A Complete Range of Engineered Noise Control
for Air Handling Systems



- Quiet-Duct Ultra™ /Low
- Quiet-Duct Ultra™ /Green
- Quiet-Duct Ultra™ /ZAPD
- Quiet-Duct Ultra® Commercial Series
- Quiet-Duct Clean Flow™ Silencers
- Quiet-Duct Conic Flow®
- D-Duct Diffuser
- Ultra-Pals™ Packless
- Quiet-Duct® Elbow Silencers



Table of Contents

Quiet-Duct Ultra™ Silencers Intro	3
Silencer Performance	4
Dynamics of Duct Silencer Design	4
Forward and Reverse Flow	4
Silencer Applications	5
Passive Silencer Design	6
Information on Silencer Specification	6
Locating Silencers in Relation to Other Components	7

Guidelines for Locating Silencers

Ducted Centrifugal Fans	8
Ducted 50% Hub-Vane Axial Fans	8
Elbows (Without Turning Vanes)	8
Elbows (With Turning Vanes).	8
Transitions	9
Coils and Filters	9
Cooling Towers & Condensers	9
At System Entrance or Exit	9
Reducing Pressure Drop Factors	9
Operation and Maintenance	10

Quiet-Duct Ultra™ / Low

Specifications	11
ULS1	12-13
ULS2	14-15
ULS3	16-17
ULM1	18-19
ULM2	20-21
ULM3	22-23
ULL1	24-25
ULL2	26-27
ULL3	38-29

Quiet-Duct Ultra™ / Green

Specifications	30
Introduction/Overview	31
UGLFS	32-33
UGLFM	34-35
UGLFL	36-37
UGS	38-39
UGMS	40-41
UGML	42-43
UGL	44-45

Quiet-Duct Ultra™ / ZAPD

Specifications	46
Z6A	47
Z6B	48
Z6C	49
Z6D	50
Z6E	51
Z9A	52
Z9B	53
Z9C	54
Z9D	55
Z9E	56
Z12A	57

Z12B	58
Z12C	59
Z12D	60

Quiet-Duct® Commercial Series

Specifications	61
LFS	62-63
LFM	64-65
S	66-67
ES	68-69
MS	70-71
LFL	72-73
ML	74-75
L	76-77

Quiet-Duct Clean Flow™ Silencers

Specifications	78
HLFS	79-80
HLFM	81-82
HS	83-84
HMS	85-86
HLFL	87-88
HML	89-90
HL	91-92

Quiet-Duct Conic Flow®

Specifications	93
FCS	94-95
FCL	96-97
CS	98-99
CL	100-101
NS	102-103
NL	104-105

D-Duct Diffuser

Specifications	106
DDS	107-108

Ultra-Pals Packless™

Specifications	109
XM	110-111
XL	112-113
KL	114-115
KM	116-117
TXS /TXL	118-119
TXLB	120-121

Quiet-Duct® Elbow Silencers

Specifications	122
ELBM-LFS	123-124
ELBM-LFM	125-126
ELBM-LFL	127-128
ELBM-MS	129-130
ELBM-ML	131-132
ELBM-S	133-134
ELBM-ES	135-136



Quiet-Duct® Silencers

A Complete Range of Engineered Noise Control for Air Handling Systems

The **Quiet-Duct® Commercial** line of silencers are the back-bone of IAC's HVAC silencers. Hundreds of sizes have been designed and pre-engineered and tested for acoustical performance and aerodynamic efficiency. These are the most used and spec'd out silencers within the HVAC industry. They provide an awesome design flexibility suitable for many different types of applications and can be easily fitted into any existing system.

The **Quiet-Duct Ultra™ /Low** line of silencers offers the industry's first published and guaranteed performance data in the 31.5 Hz full octave-band center frequencies. The tests were conducted using scale modeling developed by IAC America in cooperation with K. Uno Ingard, co-author of Theoretical Acoustics.

The **Quiet-Duct Ultra™ /Green** line was developed in response to the trend for environmentally friendly building products. This 100% environmentally friendly attenuation solution uses recycled acoustic fill material and delivers performance that meets or exceeds that of a standard Quiet-Duct silencer.

The **Quiet-Duct Ultra™ /ZAPD** line was designed for applications in which acoustic attenuation is required and no allowance can be made for pressure loss. A Zero-Added-Pressure-Drop silencer is ideal for high velocity systems or systems that have little or no room for additional pressure drop.

Features

- Forward and reverse flow
- Aero-acoustic
- Rating certified in accordance with ASTM E 477 and ISO 7235

Leadership in Silencer Development & Technology

Performance: Duct Lining vs. Silencer

A question frequently asked by our customers is whether duct lining alone can provide sufficient attenuation from noise handling equipment. In most cases the answer is “no.”

As an example based on the guidelines from the 1999 ASHRAE Fundamentals Handbook, in the 250 Hz octave band, an 18 in. x 54 in. duct would require 57 feet of one-inch-thick, 1.5 lb/ft.³-density, surface-coated, duct-liner material to achieve as much insertion loss (i.e. 32 dB) as one five-foot-long IAC 5 LFS Silencer. In the lower frequencies, such as 125 Hz, even greater lengths of duct lining would be required to achieve the 10-20 dB insertion loss typically achievable by many of the broad range of IAC silencers including the LFS series.

Dynamics of Duct Silencer Design

Proper structural design assures long, trouble-free life. The attributes of a typical Quiet-Duct Silencer include:

1. Die-formed, single-piece splitter construction throughout.
2. Shell-noise radiation minimized by double-skin or splitter construction in most models.
3. Acoustic baffles designed for maximum attenuation at low frequencies, the toughest job of all.
4. Straight-through air passages designed for maximum air handling at minimum pressure drop.
5. Solid, rounded noses that increase noise reduction.
6. Bell-mouth entrance and exit to minimize turbulence, pressure drop and self noise.
7. No protruding fastener heads to cause turbulence or self-noise.
8. Solid air-impingement surfaces and self-cleaning air passages to minimize dirt entrapment.
9. Acoustic fill protected against erosion by perforated metal containments.

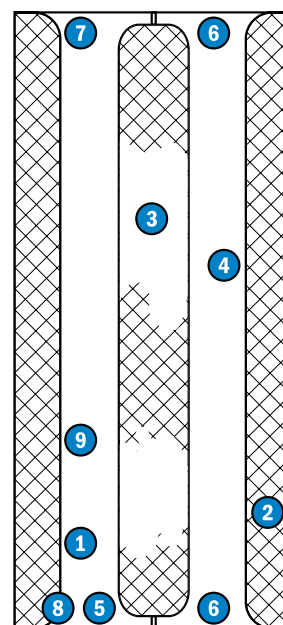

Forward & Reverse Flow

In 1972, IAC developed silencer Dynamic Insertion Loss and Self-Noise ratings both under Forward Flow (+) and Reverse Flow (-) conditions for rectangular and cylindrical silencers.

Since attenuation values are generally higher in the first five octave bands in the reverse flow mode compared to the forward flow mode, more economical silencer selections can often be made on return air systems.

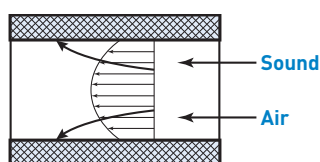

Forward Flow occurs when air and sound waves travel in the same direction, as in an air conditioning system or fan discharge. Under forward flow conditions, high frequency sound is refracted into the duct silencer walls.

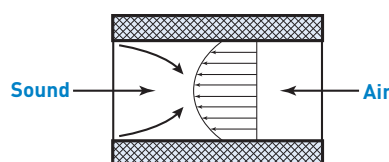

Reverse Flow occurs when air and sound waves travel in opposite directions, as in a typical return-air system. Under reverse flow conditions, sound is refracted away from the walls and towards the center of the duct silencer.

A Complete Family of Silencers

All of LAC's silencers were developed in response to specific requirements from acoustical consultants, consulting engineers, owners, and contractors. Having been pre-tested for performance, they provide the most economical choices for solving the wide variety of noise control problems encountered in HVAC engineering.

LAC standard, rectangular silencer cross sections range from 6 in. x 6 in. to 48 in. x 48 in. For small mains, branches, and duct run-outs, module sizes fit every need. When large silencer banks are required, multiple-module assemblies can be arranged to provide almost limitless dimensional flexibility.

Silencer	Application
Quiet-Duct Ultra™/Low	For conventional applications where guaranteed performance is required down to 31.5 Hz, including finer resolution of one-third-octave-band data for applications requiring full octave band performance to match specific sound sources.
Quiet-Duct Ultra™/Green	A 100% environmentally friendly attenuation solution. Silence is achieved through the use of recycled acoustic fill material. Ideal for any clean and green application.
Quiet-Duct Ultra™/ZAPD	For applications in which acoustic attenuation is required and no allowance can be made for pressure loss. A Zero-Added-Pressure-Drop silencer is ideal for high velocity systems or systems that have little or no room for additional pressure drop.
Quiet-Duct® Commercial Series	For conventional applications including low frequency. Silencers are specifically engineered to enhance insertion loss in the 63 Hz, 125 Hz, and 250 Hz octave bands.
Clean-Flow™ Rectangular Silencers	For systems requiring a higher degree of cleanliness and hygiene such as in hospitals or clean rooms. Linings on the fill material guard against erosion of particulate matter into the air-stream. Specific internal construction features protect the lining against chafing or premature failure and are necessary to maintain the rated aero-acoustic performance.
Conic-Flow® Tubular Silencers	For silencer applications including low frequency. Silencers are specifically engineered to enhance insertion loss in the 63 Hz, 125 Hz, and 250 Hz octave bands.
D-Duct™ Acoustic Diffuser Silencers	For use on axial-fan systems. The combined interior diffuser cone and exterior square jacket casing make these units aerodynamic-regain devices as well as silencers.
Ultra-Pals™ Rectangular Packless Silencers	<p>The ultimate solution for ultra-clean environments and corrosive/flammable environments. The complete absence of fill makes Ultra-Pals™ Packless Silencers ideally suited for any application where particulate matter or fiber erosion from conventional fill materials could contaminate the air/gas streams.</p> <p>The complete absence of fill, combined with ease of cleaning and draining, make Ultra-Pals™ Silencers ideal in corrosive/flammable environments and for facilities handling gasoline, grease, solvents, and other hazardous materials.</p>
Ultra-Pals™ Tubular Packless Silencers	For small-diameter circular duct systems such as fume hoods. Additionally, the packless design of these units makes them equally applicable to the types of systems mentioned for the Rectangular Ultra-Pals™ Silencers.

One Stop for Silencer Information & Specification

Benefits of Passive Silencer Design

All of the silencers manufactured by IAC are of passive design which means that they do not require mechanical or electrical means to function. They work by providing a trouble-free static means for dissipating sound energy by converting it into minute quantities of heat. Passive silencers provide low first cost, simple installation, and maintenance-free lifetime operation to make them the natural choice in HVAC-engineered noise control.

Sources of Design Information

The effective and economical application of noise control methods depends on an accurate knowledge of the system's silencing requirements. There are several sources of information available for determining the required noise reduction for a wide range of HVAC applications. The ASHRAE Handbook presents a procedure for calculating the noise reduction required. IAC also offers several methods which conform to the guide and quickly yield accurate results for specific issues.

HVAC Noise Control Issue	Methodology
Evaluation of the Entire HVAC Air Distribution System	IAC HVAC Virtual Tool A cloud-based sales and engineering tool for our HVAC products. This tool simplifies the process for identifying compatible products through modest customer input. It is a robust software with automatic calculation of product performance built in based on user identified operating conditions. The IAC Snap Form The analysis starts with the acoustic criterion for the occupied space and then accounts for the system effects of each component such as terminals, mixing boxes, branch take-offs, elbows, ductwork, fan sources, plus room characteristics.
Cross-Talk Noise Transmission	The IAC Quiet-Vent® Catalog Silencers installed in the connecting ductwork between spaces must provide airborne noise reduction to at least match the sound transmission loss of the separating structure (wall, window, door, whichever is the least effective noise barrier). This catalogue of air-transfer silencers includes relevant comparative transmission loss data.
Cooling Tower Noise	IAC Noise Control for Cooling Towers Bulletin 1.0401.1, explains how to calculate the noise reduction required and how to apply the noise control equipment selected.
Louver Applications	IAC Noishield Louvers, Bulletin 1.0502 & the Snap II Form Bulletin 1.0503
Deciding Among Silencers	Short-Form Silencer Availability Guide This guide suggests the most effective model of silencer configuration based on 250 Hz octave band DIL attenuation. It also lists typical applications where the individual silencer models would most often be used. When a particular model has been selected, more complete aero-acoustic data can be found on the technical data sheet for that model contained in this manual.
Additional Questions or Unusual Noise Control Products	Consult Your Local IAC Representative Or Contact the HVAC Product Manager: driley@iacacoustics.com or (630) 270-1790.

One Stop for Silencer Information & Specification

Locating Silencers in Relation to Other System Components

The two following pages provide guidelines for locating silencers in air handling systems. In addition, they provide a rapid means of estimating the combined pressure drop (ΔP) due to air flow through the silencer as it is affected by the silencer's location with respect to the other system components such as fans, coils, elbows, etc.

The airflow and ΔP data contained on these pages is based on tests run in accordance with applicable ASTM, AMCA, ASME and ADC test codes. These specify minimum lengths of straight duct connections up and downstream of the component under test. However, in practice, because of space considerations, it is often necessary to install silencers under conditions which vary significantly from the test procedure. Therefore, the effect of these variations must be included to determine the resultant ΔP of air flow through the silencer. The tables which follow provide multiplication factors essentially based on empirical considerations to be applied to cataloged ΔP 's.

Notes

1. For maximum structural integrity, Quiet-Duct™ Silencer splitters should be installed vertically. When vertical installation is not feasible, structural reinforcement is required for silencers wider than 24 in.
2. Unless otherwise indicated, connecting ductwork is assumed to have the same dimensions as fan intake or discharge openings.
3. When elbows are directly connected to the entrance of the silencers, the direction of the splitters should be parallel to the plane of the elbow turn.
4. L_1 = Distance from fan exhaust to entrance of discharge silencer.
 L_2 = Distance from fan inlet to exit of intake silencer.
5. ΔP Factor = Pressure Drop multiplier relative to silencer laboratory-rated-data and as specified by ASHRAE.
6. D = Diameter of round duct or equivalent diameter of rectangular duct.
7. Unless otherwise noted, multipliers shown do not include pressure drop of other components (elbows, transitions, dump losses, etc.), which must be calculated separately.
8. The ΔP Factors given are subject to minimum duct runs of 2.5 D after discharge silencers and 2.5 D before intake silencers. Otherwise, use additional multipliers as shown, such as for fans, elbows, silencers immediately at system entrance or exit, or other system components.

Note: These ΔP factors represent IAC's suggested benchmarks based on previous laboratory and field experience. While seemingly aggressive benchmarks, they will allow the user to achieve optimal performance from the silencer. In some situations, where these factors cannot be applied it may still be possible to achieve these published performance levels from your attenuator. The results will vary on a case-by-case basis and efficacy should be determined by the HVAC system engineer or by an IAC representative.

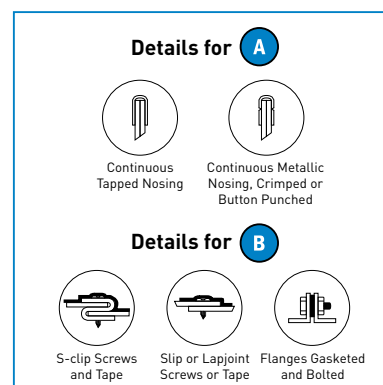
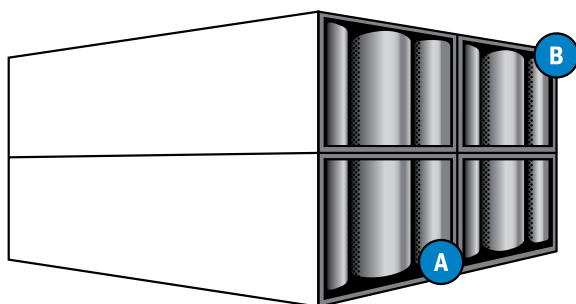

Multiple units are easily field-assembled using these types of connections.

Guidelines for Locating Silencers

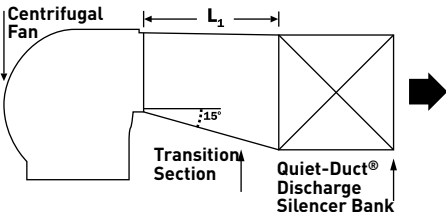
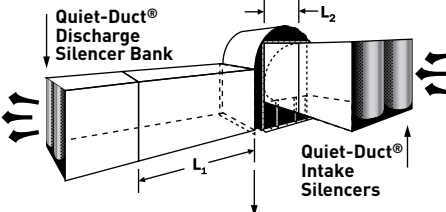
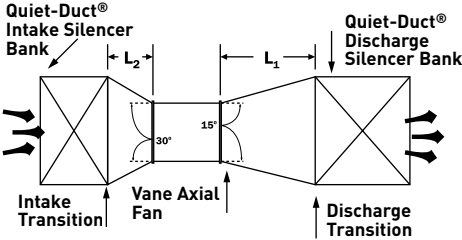
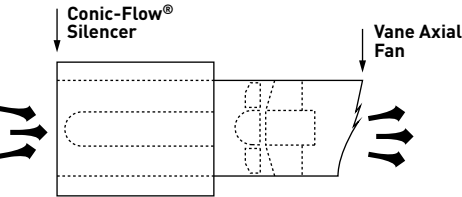
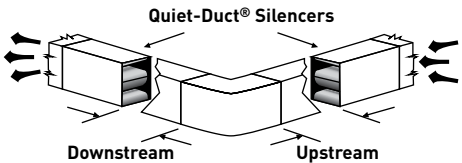
	ΔP Factor Silencer		
	Up Stream	Down Stream	
<p>Ducted Centrifugal Fans</p> <p>Discharge - Quiet-Duct® Rectangular Silencers</p> <p>a. L1 = one duct diameter for every 5fpm average duct velocity including suitably designed transition section for maximum regain</p> <p>b. If space is limited, velocity distribution vanes, diffusers, or other flow equalizers will have to be provided by system designer. Allow minimum L1 = 0.75 D</p>	-	1.0	 <p>Recommended Transition Section Arrangement Between Centrifugal Fan and Silencer Bank (Ducting not Shown)</p>  <p>Intake and Discharge Silencers for Centrifugal Fans (Ducting not Shown)</p>
<p>Intake - Quiet-Duct Rectangular Silencers</p> <p>Use minimum L2 = 0.75 D including suitably designed transition sections if required</p>	1.0	-	
<p>Ducted 50% Hub-Vane Axial Fans</p> <p>Discharge - Quiet-Duct® Rectangular Silencers</p> <p>a. L1 = one duct diameter for every 5fpm average duct velocity including transition sections of not more than 30° included angle for maximum regain</p> <p>b. When space is limited, velocity distribution vanes, diffusers, or other flow equalizers will have to be provided by system designer. Allow minimum L1 = 0.75 D</p>	-	1.0	 <p>Recommended Transition Section Arrangement Between Vane-Axial Fan and Silencer Bank (Ducting not Shown)</p>  <p>Conic-Flow® Tubular Silencer Centre Body Matched to Axial Fan Hub (Ducting not Shown)</p>
<p>Discharge - Conic-Flow® Tubular Silencers</p> <p>L1 = 0 when fan hub is matched to silencer center body</p>	-	1.0	
<p>Intake - Quiet-Duct® Rectangular Silencers</p> <p>Use minimum L2 = 0.75 D including intake cones of not more than 60° included angle</p>	1.0	-	
<p>Intake - Conic-Flow® Tubular Silencers</p> <p>L2 = 0 when fan hub is matched to silencer center body</p>	1.0	-	
<p>Elbows (Without Turning Vanes)</p> <p>Distance of silencer from elbow:</p> <p>D x 3</p> <p>D x 2</p> <p>D x 1</p>	1.0	1.0	 <p>Silencers Before and After Elbows</p> <p>Note: Silencer baffles should be parallel to the plane of the elbow turn.</p>
<p>Elbows (With Turning Vanes)</p> <p>Distance of silencer from elbow:</p> <p>D x 3</p> <p>D x 2</p> <p>D x 1</p> <p>D x 0.5</p> <p>Directly connected</p>	1.0	1.0	
	1.5	1.5	
	2.0	2.0	
	1.75	1.75	
	3.0	3.0	
	4.0	Not Advised	

Guidelines for Locating Silencers

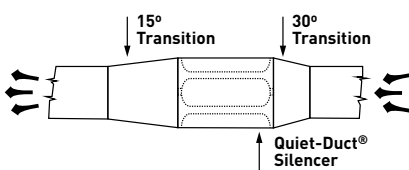
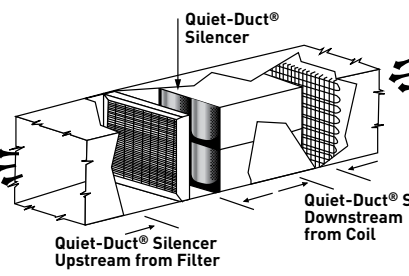
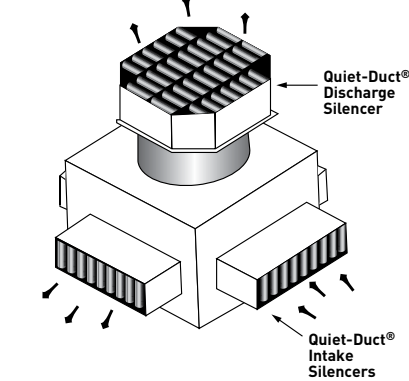
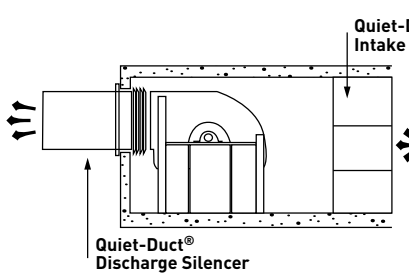
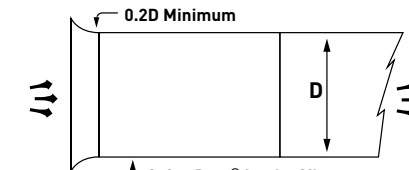
	ΔP Factor Silencer		
	Up Stream	Down Stream	
<p>Transitions</p> <p>With 15° included angle (7.5° slope) With 30° included angle (15° slope) With 60° included angle (30° slope)</p>	1.0 1.25 1.5	1.0 1.0 1.0	 <p>Silencer between Upstream and Downstream Transitions</p>
<p>Coils & Filters</p> <p>Downstream - 12" from face Upstream - 24" from face</p>	- 1.0	1.0 -	 <p>Quiet-Duct® Silencer Upstream from Filter Quiet-Duct® Silencer Downstream from Coil</p>
<p>Cooling Towers & Condensers</p> <p>All IAC Silencers</p> <p>The pressure drop increase due to the addition of silencers to a cooling tower is partially offset by the resulting decrease in the entrance and discharge losses of the system.</p>	2.0	2.0	 <p>Quiet-Duct® Discharge Silencer Quiet-Duct® Intake Silencers</p>
<p>Immediately at System Entrance or Exit</p> <p>Silencer Type or Model</p> <p>CL, FCL 2.0 5.0 NL 2.0 4.0 ML 1.5 3.5 CS, FCS, NS, L, HL, LFL, HLFL, KB 1.5 3.0 MS, LFM, HLFM, KM, KL 1.5 2.0 S, ES, SM, LFS, HLFS, XM, XL 1.5 1.5</p> <p>The relatively higher multipliers for the lower pressure drop silencers, such as the CL and L Type, for instance, are due to the dump losses to the atmosphere being significantly higher relative to their rated values.</p>			 <p>Quiet-Duct® Intake Silencer Quiet-Duct® Discharge Silencer</p> <p>Silencers Immediately at Intake and Discharge of Equipment Room</p>
<p>Pressure drop factors for silencers at the entrance to a system can be materially reduced by use of a smooth converging bell mouth with wide sides having a radius equal to at least 20% of its outlet dimension</p>			 <p>0.2D Minimum D Quiet-Duct® Intake Silencers</p>

Operation & Maintenance Instructions

1. IAC Silencers have no moving parts and therefore require no lubrication or routine maintenance.
2. All silencers are furnished rigidly constructed, well-made and free of any defects in materials or workmanship. To ensure continuing proper operation, the silencers should be visually inspected at least once a year to verify that:
 - a. Perforated acoustic splitters are undamaged, remaining parallel and true.
 - b. Airspaces between the acoustic splitters are free of any debris.
 - c. The holes in the perforated steel are open and free of dust or other foreign material.
3. In the event that debris must be cleaned from the airspaces or the perforated metal, the silencer should be vacuum-cleaned or wiped clean with a cloth dampened in a mild detergent solution.
4. In no event should solutions that might affect the galvanized protection on the steel be used to clean IAC Silencers.
5. The occurrence of "White Rust" (zinc oxide) on galvanized silencers is a normal event and not a maintenance item. It occurs when the zinc in the galvanizing reacts electrolytically with moisture to protect the steel.
6. In the event of fire, flood, structural damage or other severe occurrences, contact your local IAC Representative or the IAC Factory direct for specific instructions and recommendations.



Quiet-Duct Ultra™ / Low Silencers

Section 15000 Specifications

1.01 General

- A. Furnish and install "Quiet-Duct Ultra™/Low" (rectangular) silencers of the types and sizes shown on the plans and/or listed in the schedule. Silencers shall be the product of IAC Acoustics. Any specification change must be submitted in writing and approved by the Architect/Engineer, in writing, at least 10 days prior to the bid due-date.

2.01 Materials

- A. Casings of rectangular silencers shall be made of 22 gauge type #G-90 lock-former-quality galvanized steel.
- B. Interior partitions for rectangular silencers shall be not less than 26 gauge type #G-90 galvanized lock-former-quality perforated steel.
- C. Filler material shall be inorganic glass fiber of a proper density to obtain the specified acoustic performance and be packed under not less than 5% compression to eliminate voids due to vibration and settling. Material shall be inert, vermin- and moisture-proof.
- D. Combustion ratings for the silencer acoustic fill shall be not greater than the following when tested to ASTM E 84, NFPA Standard 255, or UL No. 723:

Flamespread Classification	20
Smoke Development Rating.....	20

3.01 Construction

- A. Units shall be constructed in accordance with the ASHRAE Guide recommendations for high pressure duct work. Seams shall be lock formed and mastic filled. Rectangular casing seams shall be in the corners of the silencer shell to provide maximum unit strength and rigidity. Interior partitions shall be fabricated from single-piece, margin-perforated sheets and shall have die-formed entrance and exit shapes so as to provide the maximum aerodynamic efficiency and minimum self-noise characteristics in the sound attenuator. Blunt noses or squared off partitions will not be accepted.
- B. Attachment of the interior partitions to the casing shall be by means of an interlocking track assembly. Tracks shall be solid galvanized steel and shall be welded to the outer casing. Attachment of the interior partitions to the tracks shall be such that a minimum of 4 thicknesses of metal exist at this location. The track assembly shall stiffen the exterior casing, provide a reinforced attachment detail for the interior partitions, and shall maintain a uniform airspace width along the length of the silencer for consistent aerodynamic and acoustic performance. Interior partitions shall be additionally secured to the outer casing with welded nose clips at both ends of the sound attenuator.

- C. Sound attenuating units shall not fail structurally when subjected to a differential air pressure of 8 inches water gauge from inside to outside the casing. Airtight construction shall be provided by use of a duct sealing compound on the jobsite material and labor furnished by the contractor.

4.01 Acoustic Performance

- A. All silencer ratings shall be determined in a duct-to-reverberant room test facility which provides for airflow in both directions through the test silencer in accordance with ASTM Specification E477-99. The test facility shall be NVLAP accredited for the ASTM E477-99 test standard. Data from a non-accredited laboratory will not be acceptable. The test set-up and procedure shall be such that all effects due to end reflection, directivity, flanking transmission, standing waves and test chamber sound absorption are eliminated.

Acoustic ratings shall include Dynamic Insertion Loss (DIL) and Self-Noise (SN) Power Levels both for FORWARD FLOW (air and noise in same direction) and REVERSE FLOW (air and noise in opposite directions) with airflow of at least 2000 fpm entering face velocity. Data for rectangular and tubular type silencers shall be presented for tests conducted using silencers no smaller than the following cross-sections:

Rectangular, inch: 24x24, 24x30, or 24x36

5.01 Aerodynamic Performance

- A. Static pressure loss of silencers shall not exceed those listed in the silencer schedule as the airflow indicates. Airflow measurements shall be made in accordance with ASTM specification E477-99 and applicable portions of ASME, AMCA, and ADC airflow test codes.

6.01 Certification

- A. With submittals, the manufacturer shall supply certified test data on Dynamic Insertion Loss, Self-Noise Power Levels, and Aerodynamic Performance for Reverse and Forward Flow test conditions. Test data shall be for a standard product. All rating tests shall be conducted in the same facility, shall utilize the same silencer, and shall be open to inspection upon request from the Architect/Engineer.

7.01 Duct Transitions

- A. When transitions are required to adapt silencer dimensions to connecting duct work they shall be furnished by the installing contractor.

Quiet-Duct Ultra™ / Low Silencers

Type: ULS1

Low Frequency Silencers with Forward & Reverse Flow Ratings

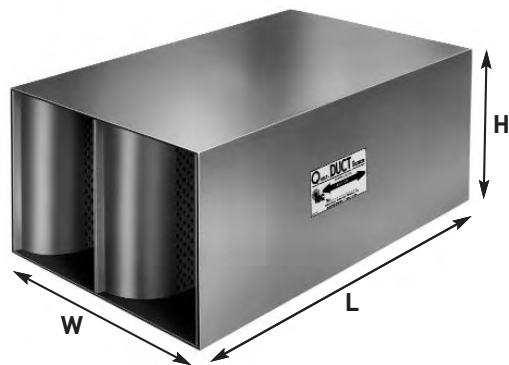

Designating Silencers

Model: 5ULS1-24-18

Type: ULS1 **Length:** 5' **Width:** 24" **Height:** 18"

First introduced back in 2005, these have been designed to optimize Dynamic Insertion Loss performance for frequencies between 25 Hz and 80 Hz. The Quiet-Duct Ultra™/Low silencers offers to the industry, first to be published by IAC, a guaranteed performance data in the 31.5 Hz full octave-band center frequencies.

ULS1 is designed to provide optimization for applications where the Dynamic Insertion Loss performance in more discrete frequencies is required to effectively control narrow-band noise sources, using a finer resolution of the 1/3 Octave Band DIL Data with Static Pressure Drop ratings +/- from 250 – 750 fpm. All Quiet-Duct Ultra™/Low silencers have been rated with procedures certified in strict accordance with ASTM E477-99 in a NVLAP Accredited Acoustical Laboratory.

Table I: Dynamic Insertion Loss (DIL) Ratings: Forward (+) / Reverse (-) Flow

IAC Model	Octave Band	0	1	2	3	4	5	6	7	8
	Hz	31.5	63	125	250	500	1K	2K	4K	8K
	Face Velocity, fpm	Dynamic Insertion Loss, dB								
3ULS1	-750	3	6	15	22	24	22	17	14	13
	-500	2	6	15	22	24	22	18	14	13
	-250	2	6	14	21	24	22	18	14	13
	250	2	6	14	21	24	22	18	14	13
	500	2	6	14	21	23	22	18	14	13
	750	2	5	13	20	23	22	18	14	13
5ULS1	-750	4	10	22	35	38	34	25	17	16
	-500	4	10	22	34	38	34	25	17	16
	-250	4	10	21	34	38	34	25	18	16
	250	4	9	20	33	37	34	25	18	16
	500	3	9	20	32	37	34	25	18	16
	750	3	9	20	32	36	34	25	18	16
7ULS1	-750	6	14	29	43	47	43	31	20	17
	-500	6	13	28	42	46	42	31	20	18
	-250	5	13	28	42	46	42	31	20	18
	250	5	12	27	41	45	42	31	21	18
	500	5	12	26	41	45	42	31	21	19
	750	4	11	25	40	45	42	31	21	19
10ULS1	-750	8	19	39	52	54	52	38	24	21
	-500	8	19	38	52	54	52	38	24	21
	-250	8	18	37	51	54	52	38	25	21
	250	7	17	36	51	54	51	38	25	22
	500	6	16	35	50	54	51	38	25	22
	750	6	15	34	50	53	51	38	25	23

(+) Forward Flow / (-) Reverse Flow. Aero-acoustic performance data based on NVLAP accredited laboratory tests conducted in strict accordance with ASTM E477-99. Contact IAC if attenuation in excess of 50 dB is required.

Table II: Weights & Measures*

Nominal Length	W/In H/In	15 12	15 18	15 24	15 30	15 36	15 42	15 48	30 12	30 18	30 24	30 30	30 36	30 42	30 48
3'	Wt/lb.	35	43	51	58	66	74	82	57	68	79	91	102	113	124
5'		57	69	82	94	106	118	131	93	110	127	144	161	178	195
7'		79	96	113	129	146	163	179	129	152	175	198	221	244	267
10'		113	136	159	183	206	229	253	183	215	246	278	310	N/A	N/A

*Note: Widths are available from 12" to 18" and from 24" to 36"

Table III: Aerodynamic Performance

Silencer Face Area is the cross-sectional area at the air entering face of the module or bank of modules. The Face Velocity is the CFM of airflow divided by the Face Area (in square feet). Pressure Drop for any face velocity can be calculated from the equation:

$$PD = (\text{Actual FV}/\text{Catalog FV})^2(\text{Catalog PD}).$$

PD values are per ASTM E477 test standard. For the smaller widths available add 15% and subtract 5% for the larger widths available. If silencers are near elbows, transitions or other non-ideal conditions sufficient allowances must be made to account for system effects when calculating the overall silencer pressure loss.

IAC Model	Static Pressure Drop, i.w.g.						
ULS1	3'	0.07	0.29	0.66	N/A	N/A	N/A
	5'	0.09	0.35	0.78	N/A	N/A	N/A
	7'	0.10	0.40	0.90	N/A	N/A	N/A
	10'	0.12	0.48	N/A	N/A	N/A	N/A
Silencer Face Velocity, fpm	250	500	750	1000	1250	1500	

Table IV: 1/3 Octave Band DIL Data

IAC Model	Octave Band	31.5 Hz			63 Hz		
	Hz	25	31.5	40	50	63	80
	Silencer Face Velocity, fpm						
3ULS1	-750	2	2	3	5	6	9
	-500	2	2	3	5	6	9
	-250	2	2	3	4	6	9
	250	2	2	3	4	6	8
	500	2	2	3	4	5	8
	750	2	2	3	4	5	8
5ULS1	-750	3	4	6	8	11	14
	-500	3	4	5	8	10	14
	-250	3	4	5	7	10	14
	250	3	4	5	7	9	13
	500	3	3	5	7	9	13
	750	3	3	4	6	9	12
7ULS1	-750	5	6	8	11	15	20
	-500	4	6	8	11	14	19
	-250	4	5	7	10	14	19
	250	4	5	7	9	13	18
	500	4	5	6	9	12	17
	750	3	4	6	9	12	17
10ULS1	-750	6	8	12	16	21	28
	-500	6	8	11	15	20	27
	-250	6	8	11	15	20	26
	250	5	7	10	13	18	24
	500	5	6	9	13	17	24
	750	4	6	9	12	17	23

One-Third (1/3) Octave Band data for IAC Quiet-Duct Ultra™/Low silencers is provided for those applications where Dynamic Insertion Loss performance in more discrete frequencies is required to effectively control narrow-band noise sources. Table IV presents the 1/3 Octave Band DIL components that combine to comprise the Full Octave Band DIL values.

Table V: Self-Noise Power Levels, dB re: 10-12 Watts

IAC Model	Octave Band	0	1	2	3	4	5	6	7	8
	Hz	31.5*	63	125	250	500	1K	2K	4K	8K
	Silencer Face Velocity, fpm									
ULS1	-750	54	51	50	48	48	51	54	47	40
	-250	34	31	24	24	24	32	34	>20	>20
	+250	33	30	23	23	23	31	33	>20	>20
	+750	53	50	49	47	47	50	53	46	39

Self-Noise values are shown for a five-square-foot area silencer. For each doubling of the face area add three dB; for each halving of the face area, subtract three dB from the values in Table V.

* Estimated

Quiet-Duct Ultra™ / Low Silencers

Type: ULS2

Low Frequency Silencers with Forward & Reverse Flow Ratings

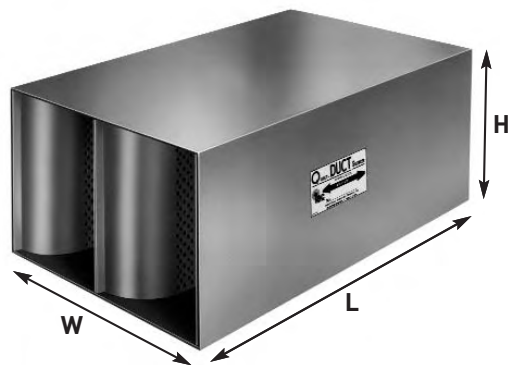

Designating Silencers

Model: 5ULS2-24-18

Type: ULS2 **Length:** 5' **Width:** 24" **Height:** 18"

First introduced back in 2005, these have been designed to optimize Dynamic Insertion Loss performance for frequencies between 25 Hz and 80 Hz. The Quiet-Duct Ultra™/Low silencers offers to the industry, first to be published by IAC, a guaranteed performance data in the 31.5 Hz full octave-band center frequencies.

ULS2 is designed to provide optimization for applications where the Dynamic Insertion Loss performance in more discrete frequencies is required to effectively control narrow-band noise sources, using a finer resolution of the 1/3 Octave Band DIL Data with Static Pressure Drop ratings +/- from 250 – 750 fpm. All Quiet-Duct Ultra/Low silencers have been rated with procedures certified in strict accordance with ASTM E477-99 in a NVLAP Accredited Acoustical Laboratory.

Table I: Dynamic Insertion Loss (DIL) Ratings: Forward (+) / Reverse (-) Flow

IAC Model	Octave Band	0	1	2	3	4	5	6	7	8
	Hz	31.5	63	125	250	500	1K	2K	4K	8K
	Face Velocity, fpm	Dynamic Insertion Loss, dB								
3ULS2	-750	3	8	16	19	19	16	14	12	11
	-500	3	8	15	19	19	16	14	12	11
	-250	3	8	15	19	19	17	14	12	11
	250	3	7	15	18	19	17	14	12	11
	500	3	7	15	18	19	17	14	12	11
	750	3	7	14	18	19	17	14	12	11
5ULS2	-750	5	12	23	29	29	23	18	15	13
	-500	5	12	23	29	29	23	18	15	13
	-250	5	11	2	28	29	24	18	15	13
	250	4	11	2	28	29	24	18	15	13
	500	4	11	21	27	29	24	18	15	14
	750	4	10	21	27	29	24	18	15	14
7ULS2	-750	7	16	30	39	39	30	22	17	15
	-500	6	15	30	38	39	30	22	18	15
	-250	6	15	29	38	39	31	22	18	16
	250	6	14	28	37	38	31	22	18	16
	500	6	14	28	36	38	31	22	18	16
	750	5	14	27	36	38	31	22	18	16
10ULS2	-750	9	21	38	46	47	38	26	20	18
	-500	9	21	38	46	47	38	26	20	18
	-250	9	20	37	46	47	38	26	21	18
	250	8	19	36	45	46	38	26	21	19
	500	8	18	36	45	46	38	26	21	19
	750	7	18	35	44	46	38	26	21	19

(+) Forward Flow / (-) Reverse Flow. Aero-acoustic performance data based on NVLAP accredited laboratory tests conducted in strict accordance with ASTM E477-99. Contact IAC if attenuation in excess of 50 dB is required.

Table II: Weights & Measures*

Nominal Length	W/In H/In	21 12	21 18	21 24	21 30	21 36	21 42	21 48	42 12	42 18	42 24	42 30	42 36	42 42	42 48
3'	Wt/lb.	42	50	59	67	76	84	93	70	83	96	108	121	134	147
5'		68	81	94	108	121	134	147	114	133	153	172	191	210	229
7'		94	112	130	148	166	184	202	158	184	210	235	261	N/A	N/A
10'		134	159	184	209	234	259	284	224	260	295	N/A	N/A	N/A	N/A

*Note: Widths are available from 18" to 24" and from 36" to 48"

Table III: Aerodynamic Performance

Silencer Face Area is the cross-sectional area at the air entering face of the module or bank of modules. The Face Velocity is the CFM of airflow divided by the Face Area (in square feet). Pressure Drop for any face velocity can be calculated from the equation:

$$PD = (\text{Actual FV}/\text{Catalog FV})^2(\text{Catalog PD}).$$

PD values are per ASTM E477 test standard. For the smaller widths available add 15% and subtract 5% for the larger widths available. If silencers are near elbows, transitions or other non-ideal conditions sufficient allowances must be made to account for system effects when calculating the overall silencer pressure loss.

IAC Model	Static Pressure Drop, i.w.g.						
ULS2	3'	0.07	0.27	0.60	N/A	N/A	N/A
	5'	0.08	0.30	0.68	N/A	N/A	N/A
	7'	0.08	0.34	0.76	N/A	N/A	N/A
	10'	0.10	0.39	0.88	N/A	N/A	N/A
Silencer Face Velocity, fpm	250	500	750	1000	1250	1500	

Table IV: 1/3 Octave Band DIL Data

IAC Model	Octave Band	31.5 Hz			63 Hz		
	Hz	25	31.5	40	50	63	80
	Silencer Face Velocity, fpm						
3ULS2	-750	2	3	4	6	9	12
	-500	2	3	4	6	9	11
	-250	2	3	4	6	8	11
	250	2	3	4	5	8	11
	500	2	3	4	5	8	11
	750	2	3	4	5	8	10
5ULS2	-750	4	5	7	9	13	17
	-500	3	5	7	9	13	16
	-250	3	5	6	9	12	16
	250	3	4	6	8	12	15
	500	3	4	6	8	11	15
	750	3	4	6	8	11	15
7ULS2	-750	5	7	9	13	17	22
	-500	5	7	9	12	17	21
	-250	5	6	9	12	16	21
	250	4	6	8	11	15	20
	500	4	6	8	11	15	19
	750	4	5	8	11	15	19
10ULS2	-750	7	10	13	18	23	29
	-500	7	9	13	17	23	29
	-250	6	9	12	17	22	28
	250	6	8	11	16	21	27
	500	6	8	11	15	20	26
	750	5	8	11	15	20	26

One-Third (1/3) Octave Band data for IAC Quiet-Duct Ultra™/Low silencers is provided for those applications where Dynamic Insertion Loss performance in more discrete frequencies is required to effectively control narrow-band noise sources. Table IV presents the 1/3 Octave Band DIL components that combine to comprise the Full Octave Band DIL values.

Table V: Self-Noise Power Levels, dB re: 10-12 Watts

IAC Model	Octave Band	0	1	2	3	4	5	6	7	8
	Hz	31.5*	63	125	250	500	1K	2K	4K	8K
	Silencer Face Velocity, fpm									
ULS2	-750	55	52	52	49	49	53	55	48	42
	-250	35	32	25	26	25	33	36	>20	>20
	+250	33	30	23	23	23	31	33	>20	>20
	+750	53	50	49	47	47	50	53	46	39

Self-Noise values are shown for a five-square-foot area silencer. For each doubling of the face area add three dB; for each halving of the face area, subtract three dB from the values in Table V.

* Estimated

Quiet-Duct Ultra™ / Low Silencers

Type: ULS3

Low Frequency Silencers with Forward & Reverse Flow Ratings

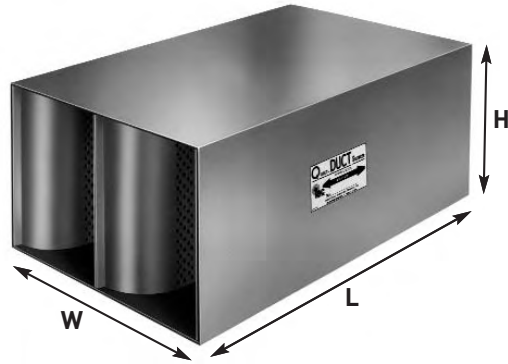

Designating Silencers

Model: 5ULS3-24-18

Type: ULS3 **Length:** 5' **Width:** 24" **Height:** 18"

First introduced back in 2005, these have been designed to optimize Dynamic Insertion Loss performance for frequencies between 25 Hz and 80 Hz. The Quiet-Duct Ultra™/Low silencers offers to the industry, first to be published by IAC, a guaranteed performance data in the 31.5 Hz full octave-band center frequencies.

ULS3 is designed to provide optimization for applications where the Dynamic Insertion Loss performance in more discrete frequencies is required to effectively control narrow-band noise sources, using a finer resolution of the 1/3 Octave Band DIL Data with Static Pressure Drop ratings +/- from 250 – 750 fpm. All Quiet-Duct Ultra/Low silencers have been rated with procedures certified in strict accordance with ASTM E477-99 in a NVLAP Accredited Acoustical Laboratory.

Table I: Dynamic Insertion Loss (DIL) Ratings: Forward (+) / Reverse (-) Flow

IAC Model	Octave Band	0	1	2	3	4	5	6	7	8
	Hz	31.5	63	125	250	500	1K	2K	4K	8K
	Face Velocity, fpm	Dynamic Insertion Loss, dB								
3ULS3	-750	4	10	15	17	16	14	12	11	9
	-500	4	10	15	17	16	14	12	11	9
	-250	4	10	15	17	16	14	12	11	9
	250	3	9	14	17	16	15	12	11	9
	500	3	9	14	16	16	15	12	11	9
	750	3	9	14	16	16	15	12	11	9
5ULS3	-750	6	14	22	25	23	18	15	13	11
	-500	6	14	22	25	23	18	15	13	11
	-250	5	13	21	25	23	19	15	13	11
	250	5	13	21	24	23	19	15	13	11
	500	5	13	20	24	23	19	15	13	11
	750	5	12	20	24	23	19	15	13	11
7ULS3	-750	8	17	29	33	30	23	17	15	13
	-500	7	17	28	32	30	23	17	15	13
	-250	7	17	28	32	30	23	17	15	13
	250	7	16	27	31	30	23	17	15	13
	500	7	16	27	31	30	23	17	15	14
	750	6	15	26	31	30	23	17	15	14
10ULS3	-750	10	23	38	44	40	29	20	18	15
	-500	10	22	37	43	40	30	20	18	15
	-250	10	22	37	43	40	30	20	18	15
	250	9	21	36	42	40	30	21	19	15
	500	9	20	35	41	40	30	21	19	15
	750	8	20	35	41	40	30	21	19	16

(+) Forward Flow / (-) Reverse Flow. Aero-acoustic performance data based on NVLAP accredited laboratory tests conducted in strict accordance with ASTM E477-99. Contact IAC if attenuation in excess of 50 dB is required.

Table II: Weights & Measures*

Nominal Length	W/In H/In	27 12	27 18	27 24	27 30	27 36	27 42	27 48	54 12	54 18	54 24	54 30	54 36	54 42	54 48
3'	Wt/lb.	48	58	67	76	86	95	104	83	98	112	126	141	155	169
5'		79	93	107	121	136	150	164	136	157	178	199	221	242	263
7'		109	128	147	167	186	205	224	178	216	244	272	301	N/A	N/A
10'		154	181	208	236	261	288	315	N/A	N/A	N/A	N/A	N/A	N/A	N/A

*Note: Widths are available from 24" to 30" and from 48" to 54"

Table III: Aerodynamic Performance

Silencer Face Area is the cross-sectional area at the air entering face of the module or bank of modules. The Face Velocity is the CFM of airflow divided by the Face Area (in square feet). Pressure Drop for any face velocity can be calculated from the equation:

$$PD = (\text{Actual FV}/\text{Catalog FV})^2(\text{Catalog PD}).$$

PD values are per ASTM E477 test standard. For the smaller widths available add 15% and subtract 5% for the larger widths available. If silencers are near elbows, transitions or other non-ideal conditions sufficient allowances must be made to account for system effects when calculating the overall silencer pressure loss.

IAC Model	Static Pressure Drop, i.w.g.						
ULS2	3'	0.06	0.25	0.57	N/A	N/A	N/A
	5'	0.07	0.28	0.63	N/A	N/A	N/A
	7'	0.08	0.30	0.68	N/A	N/A	N/A
	10'	0.09	0.34	0.77	N/A	N/A	N/A
Silencer Face Velocity, fpm	250	500	750	1000	1250	1500	

Table IV: 1/3 Octave Band DIL Data

IAC Model	Octave Band	31.5 Hz			63 Hz		
	Hz	25	31.5	40	50	63	80
	Silencer Face Velocity, fpm						
3ULS3	-750	3	4	5	8	11	13
	-500	3	4	5	8	10	12
	-250	3	3	5	8	10	12
	250	2	3	5	7	10	12
	500	2	3	5	7	10	12
	750	2	3	4	7	9	11
5ULS3	-750	4	6	8	11	15	18
	-500	4	6	8	11	14	18
	-250	4	5	7	11	14	17
	250	4	5	7	10	14	17
	500	4	5	7	10	13	16
	750	3	5	7	10	13	16
7ULS3	-750	6	8	11	15	19	23
	-500	6	8	10	14	18	23
	-250	5	7	10	14	18	22
	250	5	7	10	13	17	21
	500	5	7	9	13	17	21
	750	5	6	9	13	16	21
10ULS3	-750	8	11	15	19	24	30
	-500	8	11	14	19	24	30
	-250	7	10	14	19	23	29
	250	7	10	13	18	22	28
	500	7	9	13	17	22	28
	750	6	9	12	17	22	27

One-Third (1/3) Octave Band data for IAC Quiet-Duct Ultra™/Low silencers is provided for those applications where Dynamic Insertion Loss performance in more discrete frequencies is required to effectively control narrow-band noise sources. Table IV presents the 1/3 Octave Band DIL components that combine to comprise the Full Octave Band DIL values.

Table V: Self-Noise Power Levels, dB re: 10-12 Watts

IAC Model	Octave Band	0	1	2	3	4	5	6	7	8
	Hz	31.5'	63	125	250	500	1K	2K	4K	8K
	Silencer Face Velocity, fpm									
ULS2	-750	56	53	53	50	51	54	56	50	43
	-250	37	34	26	27	27	34	37	20	<20
	+250	33	30	23	23	23	31	33	<20	<20
	+750	53	50	49	47	47	50	53	46	39

Self-Noise values are shown for a five-square-foot area silencer. For each doubling of the face area add three dB; for each halving of the face area, subtract three dB from the values in Table V.

* Estimated

Quiet-Duct Ultra™ / Low Silencers

Type: ULM1

Low Frequency Silencers with Forward & Reverse Flow Ratings

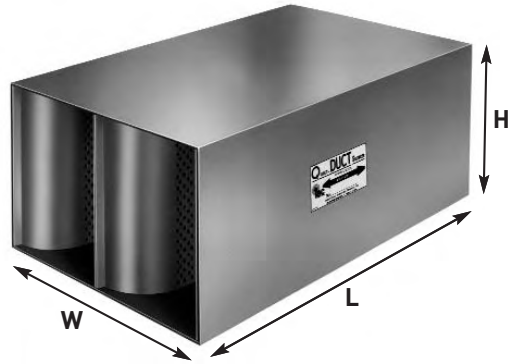

Designating Silencers

Model: 5ULM1-24-18

Type: ULM1 **Length:** 5' **Width:** 24" **Height:** 18"

First introduced back in 2005, these have been designed to optimize Dynamic Insertion Loss performance for frequencies between 25 Hz and 80 Hz. The Quiet-Duct Ultra™/Low silencers offers to the industry, first to be published by IAC, a guaranteed performance data in the 31.5 Hz full octave-band center frequencies.

ULM1 is designed to provide optimization for applications where the Dynamic Insertion Loss performance in more discrete frequencies is required to effectively control narrow-band noise sources, using a finer resolution of the 1/3 Octave Band DIL Data with Static Pressure Drop ratings +/- from 250–1000 fpm. All Quiet-Duct Ultra™/Low silencers have been rated with procedures certified in strict accordance with ASTM E477-99 in a NVLAP Accredited Acoustical Laboratory.

Table I: Dynamic Insertion Loss (DIL) Ratings: Forward (+) / Reverse (-) Flow

IAC Model	Octave Band	0	1	2	3	4	5	6	7	8
	Hz	31.5	63	125	250	500	1K	2K	4K	8K
	Face Velocity, fpm	Dynamic Insertion Loss, dB								
3ULM1	-1000	2	6	14	20	23	20	16	13	12
	-750	2	6	13	20	22	20	16	13	12
	-500	2	6	13	20	22	20	16	13	12
	500	2	5	12	19	22	20	17	13	12
	750	2	5	12	18	21	20	17	13	12
	1000	2	5	12	18	21	21	17	13	12
5ULM1	-1000	4	9	20	32	36	31	21	16	14
	-750	4	9	20	32	35	31	23	16	14
	-500	4	9	19	31	35	31	23	16	14
	500	3	8	18	29	34	31	23	16	15
	750	3	8	18	29	33	31	23	16	15
	1000	3	7	17	29	33	31	23	16	15
7ULM1	-1000	5	13	27	40	44	39	28	19	16
	-750	5	12	26	40	43	39	28	19	16
	-500	5	12	26	39	43	39	28	19	16
	500	4	11	24	37	42	39	28	19	17
	750	4	10	23	37	42	39	28	19	17
	1000	4	10	22	36	41	39	28	20	18
10ULM1	-1000	8	18	36	49	52	48	35	23	18
	-750	7	17	35	49	52	48	35	23	19
	-500	7	17	34	48	52	48	35	23	19
	500	6	14	32	47	51	48	35	23	20
	750	5	14	31	47	51	48	35	24	21
	1000	5	13	30	46	51	48	35	24	21

(+) Forward Flow / (-) Reverse Flow. Aero-acoustic performance data based on NVLAP accredited laboratory tests conducted in strict accordance with ASTM E477-99. Contact IAC if attenuation in excess of 50 dB is required.

Table II: Weights & Measures*

Nominal Length	W/In H/In	15 12	15 18	15 24	15 30	15 36	15 42	15 48	30 12	30 18	30 24	30 30	30 36	30 42	30 48
3'	Wt/lb.	35	43	50	58	66	73	81	57	68	79	90	101	112	123
5'		58	70	82	94	106	118	130	94	111	127	144	161	178	194
7'		80	97	113	130	146	162	179	131	153	176	198	221	243	266
10'		114	137	160	183	206	229	252	185	217	248	279	311	N/A	N/A

*Note: Widths are available from 12" to 18" and from 24" to 36"

Table III: Aerodynamic Performance

Silencer Face Area is the cross-sectional area at the air entering face of the module or bank of modules. The Face Velocity is the CFM of airflow divided by the Face Area (in square feet). Pressure Drop for any face velocity can be calculated from the equation:

$$PD = (\text{Actual FV}/\text{Catalog FV})^2(\text{Catalog PD}).$$

PD values are per ASTM E477 test standard. For the smaller widths available add 15% and subtract 5% for the larger widths available. If silencers are near elbows, transitions or other non-ideal conditions sufficient allowances must be made to account for system effects when calculating the overall silencer pressure loss.

IAC Model	Static Pressure Drop, i.w.g.						
ULS2	3'	0.04	0.14	0.32	0.57	N/A	N/A
	5'	0.04	0.16	0.36	0.64	N/A	N/A
	7'	0.04	0.18	0.40	0.71	N/A	N/A
	10'	0.05	0.20	0.46	0.82	N/A	N/A
Silencer Face Velocity, fpm	250	500	750	1000	1250	1500	

Table IV: 1/3 Octave Band DIL Data

IAC Model	Octave Band	31.5 Hz			63 Hz		
	Hz	25	31.5	40	50	63	80
	Silencer Face Velocity, fpm						
3ULM1	-1000	2	2	3	4	6	8
	-750	2	2	3	4	6	8
	-500	2	2	3	4	5	8
	500	1	2	3	4	5	7
	750	1	2	2	3	5	7
	1000	1	2	2	3	5	7
5ULM1	-1000	3	4	5	7	10	13
	-750	3	4	5	7	9	13
	-500	3	4	5	7	9	12
	500	2	3	4	6	8	11
	750	2	3	4	6	8	11
	1000	2	3	4	5	8	11
7ULM1	-1000	4	5	7	10	13	18
	-750	4	5	7	10	13	17
	-500	4	5	7	9	13	17
	500	3	4	6	8	11	15
	750	3	4	5	8	11	15
	1000	3	4	5	7	10	14
10ULM1	-1000	6	8	11	14	19	25
	-750	5	7	10	14	19	25
	-500	5	7	10	13	18	24
	500	4	6	8	11	16	21
	750	4	5	8	11	15	20
	1000	4	5	7	10	14	20

One-Third (1/3) Octave Band data for IAC Quiet-Duct Ultra™/Low silencers is provided for those applications where Dynamic Insertion Loss performance in more discrete frequencies is required to effectively control narrow-band noise sources. Table IV presents the 1/3 Octave Band DIL components that combine to comprise the Full Octave Band DIL values.

Table V: Self-Noise Power Levels, dB re: 10-12 Watts

IAC Model	Octave Band	0	1	2	3	4	5	6	7	8
	Hz	31.5*	63	125	250	500	1K	2K	4K	8K
	Silencer Face Velocity, fpm									
ULS2	-750	55	52	52	49	49	53	55	49	43
	-250	42	39	35	34	34	40	43	30	<20
	+250	41	38	34	33	33	39	42	29	<20
	+750	54	51	51	48	48	52	54	48	42

Self-Noise values are shown for a five-square-foot area silencer. For each doubling of the face area add three dB; for each halving of the face area, subtract three dB from the values in Table V.

* Estimated

Quiet-Duct Ultra™ / Low Silencers

Type: ULM2

Low Frequency Silencers with Forward & Reverse Flow Ratings

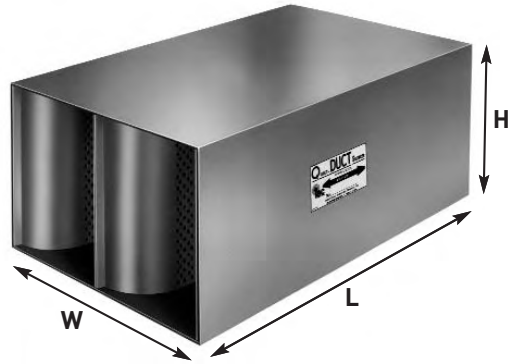

Designating Silencers

Model: 5ULM2-24-18

Type: ULM2 **Length:** 5' **Width:** 24" **Height:** 18"

First introduced back in 2005, these have been designed to optimize Dynamic Insertion Loss performance for frequencies between 25 Hz and 80 Hz. The Quiet-Duct Ultra™/Low silencers offers to the industry, first to be published by IAC, a guaranteed performance data in the 31.5 Hz full octave-band center frequencies.

ULM2 is designed to provide optimization for applications where the Dynamic Insertion Loss performance in more discrete frequencies is required to effectively control narrow-band noise sources, using a finer resolution of the 1/3 Octave Band DIL Data with Static Pressure Drop ratings +/- from 250–1000 fpm. All Quiet-Duct Ultra™/Low silencers have been rated with procedures certified in strict accordance with ASTM E477-99 in a NVLAP Accredited Acoustical Laboratory.

Table I: Dynamic Insertion Loss (DIL) Ratings: Forward (+) / Reverse (-) Flow

IAC Model	Octave Band	0	1	2	3	4	5	6	7	8
	Hz	31.5	63	125	250	500	1K	2K	4K	8K
	Face Velocity, fpm	Dynamic Insertion Loss, dB								
3ULM2	-1000	3	7	14	18	18	15	13	11	10
	-750	3	7	14	17	18	15	13	11	10
	-500	3	7	14	17	18	15	13	11	10
	500	2	7	13	16	18	16	13	11	10
	750	2	6	13	16	18	16	13	11	10
	1000	2	6	13	16	17	16	13	11	10
5ULM2	-1000	5	11	21	27	27	21	16	13	12
	-750	4	11	21	26	27	21	16	13	12
	-500	4	11	20	26	27	21	16	13	12
	500	4	10	19	25	26	22	17	14	12
	750	4	9	19	25	26	22	17	14	12
	1000	3	9	19	24	26	22	17	14	12
7ULM2	-1000	6	14	28	36	36	28	20	16	14
	-750	6	14	27	36	36	28	20	16	14
	-500	6	14	27	35	36	28	20	16	14
	500	5	13	25	33	35	28	20	16	14
	750	5	12	25	33	35	28	20	16	14
	1000	5	12	24	33	35	28	20	16	14
10ULM2	-1000	9	19	36	44	44	35	24	18	15
	-750	8	19	35	43	44	35	24	19	15
	-500	8	19	34	43	44	35	24	19	15
	500	7	17	32	41	43	35	24	19	16
	750	7	16	32	41	43	35	24	19	16
	1000	6	16	31	41	43	35	24	19	16

(+) Forward Flow / (-) Reverse Flow. Aero-acoustic performance data based on NVLAP accredited laboratory tests conducted in strict accordance with ASTM E477-99. Contact IAC if attenuation in excess of 50 dB is required.

Table II: Weights & Measures*

Nominal Length	W/In H/In	21 12	21 18	21 24	21 30	21 36	21 42	21 48	42 12	42 18	42 24	42 30	42 36	42 42	42 48
3'	Wt/lb.	42	50	59	67	75	84	92	71	83	96	108	120	133	145
5'		69	82	95	108	121	134	147	116	135	153	172	191	210	228
7'		95	113	131	149	1666	184	202	1661	186	211	236	261	N/A	N/A
10'		136	160	185	210	234	259	284	228	263	298	N/A	N/A	N/A	N/A

*Note: Widths are available from 12" to 18" and from 24" to 36"

Table III: Aerodynamic Performance

Silencer Face Area is the cross-sectional area at the air entering face of the module or bank of modules. The Face Velocity is the CFM of airflow divided by the Face Area (in square feet). Pressure Drop for any face velocity can be calculated from the equation:

$$PD = (\text{Actual FV}/\text{Catalog FV})^2(\text{Catalog PD}).$$

PD values are per ASTM E477 test standard. For the smaller widths available add 15% and subtract 5% for the larger widths available. If silencers are near elbows, transitions or other non-ideal conditions sufficient allowances must be made to account for system effects when calculating the overall silencer pressure loss.

IAC Model	Static Pressure Drop, i.w.g.						
ULM2	3'	0.03	0.13	0.30	0.53	0.83	N/A
	5'	0.04	0.14	0.33	0.58	0.91	N/A
	7'	0.04	0.16	0.35	0.63	N/A	N/A
	10'	0.04	0.17	0.39	0.70	N/A	N/A
Silencer Face Velocity, fpm	250	500	750	1000	1250	1500	

Table IV: 1/3 Octave Band DIL Data

IAC Model	Octave Band	31.5 Hz			63 Hz		
	Hz	25	31.5	40	50	63	80
	Silencer Face Velocity, fpm						
3ULM2	-1000	2	3	4	5	8	10
	-750	2	3	4	5	8	10
	-500	2	3	4	5	8	10
	500	2	2	3	5	7	9
	750	2	2	3	4	7	9
	1000	2	2	3	4	7	9
5ULM2	-1000	3	5	6	8	12	15
	-750	3	4	6	8	11	15
	-500	3	4	6	8	11	15
	500	3	4	5	7	10	13
	750	3	4	5	7	10	13
	1000	2	3	5	7	10	13
7ULM2	-1000	5	6	9	12	15	20
	-750	4	6	8	11	15	19
	-500	4	6	8	11	15	19
	500	4	5	7	10	13	17
	750	3	5	7	10	13	17
	1000	3	5	7	9	13	17
10ULM2	-1000	6	9	12	16	21	27
	-750	6	9	12	16	21	26
	-500	6	8	11	15	20	26
	500	5	7	10	14	18	24
	750	5	7	9	13	18	23
	1000	4	6	9	13	17	22

One-Third (1/3) Octave Band data for IAC Quiet-Duct Ultra™/Low silencers is provided for those applications where Dynamic Insertion Loss performance in more discrete frequencies is required to effectively control narrow-band noise sources. Table IV presents the 1/3 Octave Band DIL components that combine to comprise the Full Octave Band DIL values.

Table V: Self-Noise Power Levels, dB re: 10-12 Watts

IAC Model	Octave Band	0	1	2	3	4	5	6	7	8
	Hz	31.5'	63	125	250	500	1K	2K	4K	8K
	Silencer Face Velocity, fpm									
ULM2	-1000	56	53	53	51	51	54	56	50	44
	-500	44	41	37	36	36	42	44	32	<20
	+500	41	38	34	33	33	39	42	29	<20
	+1000	54	51	51	48	48	52	54	48	42

Self-Noise values are shown for a five-square-foot area silencer. For each doubling of the face area add three dB; for each halving of the face area, subtract three dB from the values in Table V.

* Estimated

Quiet-Duct Ultra™ / Low Silencers

Type: ULM3

Low Frequency Silencers with Forward & Reverse Flow Ratings

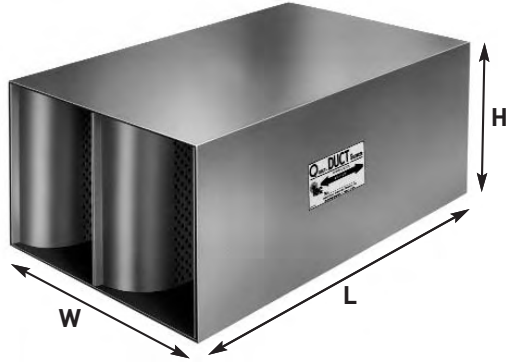

Designating Silencers

Model: 5ULM3-24-18

Type: ULM3 **Length:** 5' **Width:** 24" **Height:** 18"

First introduced back in 2005, these have been designed to optimize Dynamic Insertion Loss performance for frequencies between 25 Hz and 80 Hz. The Quiet-Duct Ultra™/Low silencers offers to the industry, first to be published by IAC, a guaranteed performance data in the 31.5 Hz full octave-band center frequencies.

ULM3 is designed to provide optimization for applications where the Dynamic Insertion Loss performance in more discrete frequencies is required to effectively control narrow-band noise sources, using a finer resolution of the 1/3 Octave Band DIL Data with Static Pressure Drop ratings +/- from 250–1000 fpm. All Quiet-Duct Ultra™/Low silencers have been rated with procedures certified in strict accordance with ASTM E477-99 in a NVLAP Accredited Acoustical Laboratory.

Table I: Dynamic Insertion Loss (DIL) Ratings: Forward (+) / Reverse (-) Flow

IAC Model	Octave Band	0	1	2	3	4	5	6	7	8
	Hz	31.5	63	125	250	500	1K	2K	4K	8K
	Face Velocity, fpm	Dynamic Insertion Loss, dB								
3ULM3	-1000	3	9	14	16	14	12	11	10	8
	-750	3	9	13	16	15	13	11	10	8
	-500	3	9	13	16	15	13	11	9	8
	500	3	8	13	15	15	14	11	9	8
	750	3	8	13	15	15	14	11	9	8
	1000	3	8	12	15	15	14	11	9	8
5ULM3	-1000	5	13	20	23	21	17	13	12	9
	-750	5	12	20	23	21	17	13	11	9
	-500	5	12	19	23	21	17	13	11	9
	500	4	11	18	22	21	17	14	11	9
	750	4	11	18	22	21	18	14	11	9
	1000	4	11	18	21	21	18	14	11	9
7ULM3	-1000	7	16	26	30	28	21	16	13	11
	-750	7	16	26	30	28	21	16	13	11
	-500	7	15	26	30	28	21	16	13	11
	500	6	14	24	29	28	21	16	13	11
	750	6	14	24	28	28	21	16	13	11
	1000	5	14	24	28	28	22	16	13	11
10ULM3	-1000	9	21	35	41	37	27	19	16	12
	-750	9	20	35	40	37	27	19	16	12
	-500	9	20	34	40	37	27	19	16	12
	500	8	18	32	38	37	27	19	16	12
	750	8	18	32	38	37	27	19	16	12
	1000	7	18	31	38	37	27	19	16	12

(+) Forward Flow / (-) Reverse Flow. Aero-acoustic performance data based on NVLAP accredited laboratory tests conducted in strict accordance with ASTM E477-99. Contact IAC if attenuation in excess of 50 dB is required.

Table II: Weights & Measures*

Nominal Length	W/In H/In	27 12	27 18	27 24	27 30	27 36	27 42	27 48	54 12	54 18	54 24	54 30	54 36	54 42	54 48
3'	Wt/lb.	48	57	67	76	85	94	103	84	98	112	125	139	153	167
5'		79	93	107	121	135	149	163	137	158	178	199	219	240	261
7'		110	129	148	167	186	204	223	191	218	245	273	300	N/A	N/A
10'		157	183	209	235	261	287	313	N/A	N/A	N/A	N/A	N/A	N/A	N/A

*Note: Widths are available from 24" to 30" and from 48" to 54"

Table III: Aerodynamic Performance

Silencer Face Area is the cross-sectional area at the air entering face of the module or bank of modules. The Face Velocity is the CFM of airflow divided by the Face Area (in square feet). Pressure Drop for any face velocity can be calculated from the equation:

$$PD = (\text{Actual FV}/\text{Catalog FV})^2(\text{Catalog PD}).$$

PD values are per ASTM E477 test standard. For the smaller widths available add 15% and subtract 5% for the larger widths available. If silencers are near elbows, transitions or other non-ideal conditions sufficient allowances must be made to account for system effects when calculating the overall silencer pressure loss.

IAC Model	Static Pressure Drop, i.w.g.						
ULM3	3'	0.03	0.13	0.29	0.51	0.80	N/A
	5'	0.03	0.14	0.31	0.55	0.86	N/A
	7'	0.04	0.15	0.33	0.58	0.91	N/A
	10'	0.04	0.16	0.36	0.64	0.99	N/A
Silencer Face Velocity, fpm	250	500	750	1000	1250	1500	

Table IV: 1/3 Octave Band DIL Data

IAC Model	Octave Band	31.5 Hz			63 Hz		
	Hz	25	31.5	40	50	63	80
	Silencer Face Velocity, fpm						
3ULM3	-1000	2	3	5	7	9	11
	-750	2	3	5	7	9	11
	-500	2	3	5	7	9	11
	500	2	3	4	6	9	10
	750	2	3	4	6	8	10
	1000	2	3	4	6	8	10
5ULM3	-1000	4	5	7	10	13	16
	-750	4	5	7	10	13	16
	-500	4	5	7	10	13	16
	500	3	4	6	9	12	15
	750	3	4	6	9	12	14
	1000	3	4	6	9	11	14
7ULM3	-1000	5	7	10	13	17	21
	-750	5	7	9	13	17	21
	-500	5	7	9	13	16	20
	500	5	7	9	13	16	20
	750	4	6	8	11	15	19
	1000	4	6	8	11	14	18
10ULM3	-1000	7	10	13	18	22	28
	-750	7	10	13	17	22	27
	-500	7	9	13	17	22	27
	500	6	8	11	15	20	25
	750	6	8	11	15	19	25
	1000	5	8	11	15	19	24

One-Third (1/3) Octave Band data for IAC Quiet-Duct Ultra™/Low silencers is provided for those applications where Dynamic Insertion Loss performance in more discrete frequencies is required to effectively control narrow-band noise sources. Table IV presents the 1/3 Octave Band DIL components that combine to comprise the Full Octave Band DIL values.

Table V: Self-Noise Power Levels, dB re: 10-12 Watts

IAC Model	Octave Band	0	1	2	3	4	5	6	7	8
	Hz	31.5'	63	125	250	500	1K	2K	4K	8K
	Silencer Face Velocity, fpm									
ULM3	-750	57	54	55	52	52	55	57	51	45
	-250	45	42	38	37	37	43	45	33	21
	+250	41	38	34	33	33	39	42	29	<20
	+750	54	51	51	48	48	52	54	48	42

Self-Noise values are shown for a five-square-foot area silencer. For each doubling of the face area add three dB; for each halving of the face area, subtract three dB from the values in Table V.

* Estimated

Quiet-Duct Ultra™ / Low Silencers

Type: ULL1

Low Frequency Silencers with Forward & Reverse Flow Ratings

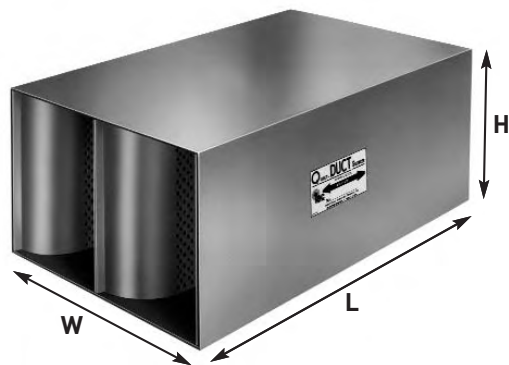

Designating Silencers

Model: 5ULL1-24-18

Type: ULL1 **Length:** 5' **Width:** 24" **Height:** 18"

First introduced back in 2005, these have been designed to optimize Dynamic Insertion Loss performance for frequencies between 25 Hz and 80 Hz. The Quiet-Duct Ultra™/Low silencers offers to the industry, first to be published by IAC, a guaranteed performance data in the 31.5 Hz full octave-band center frequencies.

ULL1 is designed to provide optimization for applications where the Dynamic Insertion Loss performance in more discrete frequencies is required to effectively control narrow-band noise sources, using a finer resolution of the 1/3 Octave Band DIL Data with Static Pressure Drop ratings +/- from 250 – 1250 fpm. All Quiet-Duct Ultra™/Low silencers have been rated with procedures certified in strict accordance with ASTM E477-99 in a NVLAP Accredited Acoustical Laboratory.

Table I: Dynamic Insertion Loss (DIL) Ratings: Forward (+) / Reverse (-) Flow

IAC Model	Octave Band	0	1	2	3	4	5	6	7	8
	Hz	31.5	63	125	250	500	1K	2K	4K	8K
	Face Velocity, fpm	Dynamic Insertion Loss, dB								
3ULL1	-1250	2	5	12	18	21	18	14	11	11
	-1000	2	5	12	18	21	18	14	11	11
	-750	2	5	12	18	20	18	15	11	11
	750	2	4	11	17	19	19	15	12	11
	1000	2	4	10	16	19	19	15	12	11
	1250	2	4	10	16	19	19	15	12	11
5ULL1	-1250	3	8	18	29	33	28	20	15	13
	-1000	3	8	18	29	32	28	20	15	13
	-750	3	8	18	28	32	28	21	15	13
	750	3	7	16	26	31	28	21	15	13
	1000	2	7	16	26	30	28	21	15	13
	1250	2	6	15	26	30	28	21	15	13
7ULL1	-1250	5	11	24	37	41	36	25	17	15
	-1000	5	11	24	36	41	36	25	17	15
	-750	4	11	23	36	40	36	25	18	15
	750	3	9	21	34	39	35	26	18	16
	1000	3	9	20	33	38	35	26	18	16
	1250	3	8	20	33	38	35	26	18	16
10ULL1	-1250	7	16	33	46	49	44	31	21	17
	-1000	6	16	32	46	49	44	31	21	17
	-750	6	15	31	45	49	44	32	21	17
	750	5	12	28	43	48	44	32	22	19
	1000	4	12	27	43	48	44	32	22	19
	1250	4	11	26	43	48	44	32	22	19

(+) Forward Flow / (-) Reverse Flow. Aero-acoustic performance data based on NVLAP accredited laboratory tests conducted in strict accordance with ASTM E477-99. Contact IAC if attenuation in excess of 50 dB is required.

Table II: Weights & Measures*

Nominal Length	W/In H/In	15 12	15 18	15 24	15 30	15 36	15 42	15 48	30 12	30 18	30 24	30 30	30 36	30 42	30 48
3'	Wt/lb.	35	43	50	58	65	73	80	58	68	79	90	100	111	122
5'		58	70	82	94	106	118	129	95	111	128	144	160	177	193
7'		81	97	114	130	146	162	178	132	154	177	199	221	243	265
10'		116	138	161	184	206	229	252	188	219	250	280	311	N/A	N/A

*Note: Widths are available from 12" to 18" and from 24" to 36"

Table III: Aerodynamic Performance

Silencer Face Area is the cross-sectional area at the air entering face of the module or bank of modules. The Face Velocity is the CFM of airflow divided by the Face Area (in square feet). Pressure Drop for any face velocity can be calculated from the equation:

$$PD = (\text{Actual FV}/\text{Catalog FV})^2(\text{Catalog PD}).$$

PD values are per ASTM E477 test standard. For the smaller widths available add 15% and subtract 5% for the larger widths available. If silencers are near elbows, transitions or other non-ideal conditions sufficient allowances must be made to account for system effects when calculating the overall silencer pressure loss.

IAC Model	Static Pressure Drop, i.w.g.						
ULL1	3'	0.03	0.10	0.23	0.41	0.64	N/A
	5'	0.03	0.12	0.26	0.47	0.73	N/A
	7'	0.03	0.13	0.29	0.52	0.82	N/A
	10'	0.04	0.15	0.34	0.60	0.94	N/A
Silencer Face Velocity, fpm	250	500	750	1000	1250	1500	

Table IV: 1/3 Octave Band DIL Data

IAC Model	Octave Band	31.5 Hz			63 Hz		
	Hz	25	31.5	40	50	63	80
	Silencer Face Velocity, fpm						
3ULL1	-1250	1	2	3	4	5	7
	-1000	1	2	3	4	5	7
	-750	1	2	3	4	5	7
	750	1	2	2	3	4	6
	1000	1	2	2	3	4	6
	1250	1	1	2	3	4	6
5ULL1	-1250	3	3	5	6	9	12
	-1000	2	3	4	6	8	11
	-750	2	3	4	6	8	11
	750	2	2	3	5	7	10
	1000	2	2	3	5	7	9
	1250	2	2	3	5	6	9
7ULL1	-1250	4	5	6	9	12	16
	-1000	3	5	6	9	12	16
	-750	3	4	6	8	11	15
	750	2	3	5	7	9	13
	1000	2	3	5	6	9	13
	1250	2	3	4	6	9	12
10ULL1	-1250	5	7	9	13	17	23
	-1000	5	6	9	12	17	22
	-750	5	6	9	12	16	22
	750	3	5	7	9	13	18
	1000	3	4	6	9	13	17
	1250	3	4	6	9	12	17

One-Third (1/3) Octave Band data for IAC Quiet-Duct Ultra™/Low silencers is provided for those applications where Dynamic Insertion Loss performance in more discrete frequencies is required to effectively control narrow-band noise sources. Table IV presents the 1/3 Octave Band DIL components that combine to comprise the Full Octave Band DIL values.

Table V: Self-Noise Power Levels, dB re: 10-12 Watts

IAC Model	Octave Band	0	1	2	3	4	5	6	7	8
	Hz	31.5*	63	125	250	500	1K	2K	4K	8K
	Silencer Face Velocity, fpm									
ULL1	-1250	55	52	53	50	50	53	56	50	44
	-750	46	43	41	39	39	44	47	36	26
	+750	45	42	40	38	38	43	46	35	25
	+1250	55	52	52	49	49	52	55	49	43

Self-Noise values are shown for a five-square-foot area silencer. For each doubling of the face area add three dB; for each halving of the face area, subtract three dB from the values in Table V.

* Estimated

Quiet-Duct Ultra™ / Low Silencers

Type: ULL2

Low Frequency Silencers with Forward & Reverse Flow Ratings

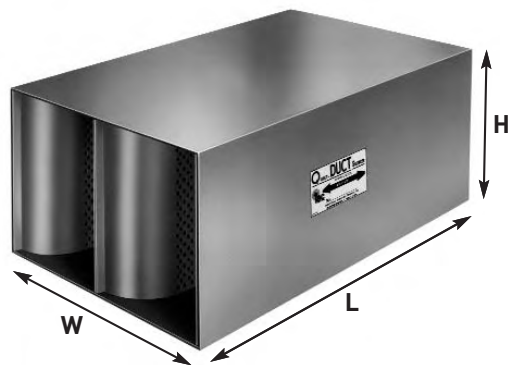

Designating Silencers

Model: 5ULL2-24-18

Type: ULL2 **Length:** 5' **Width:** 24" **Height:** 18"

First introduced back in 2005, these have been designed to optimize Dynamic Insertion Loss performance for frequencies between 25 Hz and 80 Hz. The Quiet-Duct Ultra™/Low silencers offers to the industry, first to be published by IAC, a guaranteed performance data in the 31.5 Hz full octave-band center frequencies.

ULL2 is designed to provide optimization for applications where the Dynamic Insertion Loss performance in more discrete frequencies is required to effectively control narrow-band noise sources, using a finer resolution of the 1/3 Octave Band DIL Data with Static Pressure Drop ratings +/- from 250 – 1250 fpm. All Quiet-Duct Ultra™/Low silencers have been rated with procedures certified in strict accordance with ASTM E477-99 in a NVLAP Accredited Acoustical Laboratory.

Table I: Dynamic Insertion Loss (DIL) Ratings: Forward (+) / Reverse (-) Flow

IAC Model	Octave Band	0	1	2	3	4	5	6	7	8
	Hz	31.5	63	125	250	500	1K	2K	4K	8K
	Face Velocity, fpm	Dynamic Insertion Loss, dB								
3ULL2	-1250	3	7	13	16	16	13	11	10	9
	-1000	2	6	13	16	16	14	11	10	9
	-750	2	6	12	16	16	14	11	10	9
	750	2	6	11	15	16	15	12	10	8
	1000	2	6	11	15	16	15	12	10	8
	1250	2	5	11	14	16	15	12	10	8
5ULL2	-1250	4	10	19	25	25	19	15	12	10
	-1000	4	10	19	24	25	19	15	12	10
	-750	4	9	19	24	24	19	15	12	10
	750	3	8	17	22	24	20	15	12	10
	1000	3	8	17	22	24	20	15	12	10
	1250	3	8	16	22	24	20	15	12	10
7ULL2	-1250	5	13	25	33	33	25	18	14	12
	-1000	5	13	25	33	33	25	18	14	12
	-750	5	12	24	32	33	25	18	14	12
	750	4	11	22	30	32	25	18	14	12
	1000	4	11	22	30	32	25	18	14	12
	1250	4	10	22	29	32	25	18	14	12
10ULL2	-1250	8	18	32	41	41	31	22	17	13
	-1000	7	17	32	40	41	31	22	17	13
	-750	7	17	32	40	41	31	22	17	13
	750	6	14	29	38	40	31	22	17	13
	1000	5	14	28	38	40	31	22	18	14
	1250	5	14	28	37	39	31	23	18	14

(+) Forward Flow / (-) Reverse Flow. Aero-acoustic performance data based on NVLAP accredited laboratory tests conducted in strict accordance with ASTM E477-99. Contact IAC if attenuation in excess of 50 dB is required.

Table II: Weights & Measures*

Nominal Length	W/In H/In	21 12	21 18	21 24	21 30	21 36	21 42	21 48	42 12	42 18	42 24	42 30	42 36	42 42	42 48
3'	Wt/lb.	42	50	58	67	75	83	91	71	83	95	107	119	131	143
5'		69	82	95	107	120	133	146	117	135	153	171	189	208	226
7'		96	114	131	148	166	183	200	163	187	211	236	260	N/A	N/A
10'		137	161	185	210	234	258	282	232	265	299	N/A	N/A	N/A	N/A

*Note: Widths are available from 18" to 24" and from 36" to 48"

Table III: Aerodynamic Performance

Silencer Face Area is the cross-sectional area at the air entering face of the module or bank of modules. The Face Velocity is the CFM of airflow divided by the Face Area (in square feet). Pressure Drop for any face velocity can be calculated from the equation:

$$PD = (\text{Actual FV}/\text{Catalog FV})^2(\text{Catalog PD}).$$

PD values are per ASTM E477 test standard. For the smaller widths available add 15% and subtract 5% for the larger widths available. If silencers are near elbows, transitions or other non-ideal conditions sufficient allowances must be made to account for system effects when calculating the overall silencer pressure loss.

IAC Model	Static Pressure Drop, i.w.g.						
ULL2	3'	0.02	0.10	0.22	0.38	0.60	0.87
	5'	0.03	0.11	0.24	0.42	0.66	0.95
	7'	0.02	0.11	0.26	0.46	0.72	N/A
	10'	0.03	0.13	0.29	0.51	0.80	N/A
Silencer Face Velocity, fpm	250	500	750	1000	1250	1500	

Table IV: 1/3 Octave Band DIL Data

IAC Model	Octave Band	31.5 Hz			63 Hz		
	Hz	25	31.5	40	50	63	80
	Silencer Face Velocity, fpm						
3ULL2	-1250	2	3	3	5	7	9
	-1000	2	2	3	5	7	9
	-750	2	2	3	5	7	9
	750	1	2	3	4	6	8
	1000	1	2	3	4	6	8
	1250	1	2	3	4	6	8
5ULL2	-1250	3	4	6	8	10	14
	-1000	3	4	5	7	10	13
	-750	3	4	5	7	10	13
	750	2	3	4	6	9	12
	1000	2	3	4	6	9	11
	1250	2	3	4	6	8	11
7ULL2	-1250	4	6	8	10	14	18
	-1000	4	5	7	10	14	17
	-750	4	5	7	10	13	17
	750	3	4	6	8	12	15
	1000	3	4	6	8	11	15
	1250	3	4	6	8	11	15
10ULL2	-1250	6	8	11	15	19	24
	-1000	6	8	10	14	19	24
	-750	5	7	10	14	18	23
	750	4	6	8	12	16	21
	1000	4	6	8	11	15	20
	1250	4	5	8	11	15	20

One-Third (1/3) Octave Band data for IAC Quiet-Duct Ultra™/Low silencers is provided for those applications where Dynamic Insertion Loss performance in more discrete frequencies is required to effectively control narrow-band noise sources. Table IV presents the 1/3 Octave Band DIL components that combine to comprise the Full Octave Band DIL values.

Table V: Self-Noise Power Levels, dB re: 10-12 Watts

IAC Model	Octave Band	0	1	2	3	4	5	6	7	8
	Hz	31.5'	63	125	250	500	1K	2K	4K	8K
	Silencer Face Velocity, fpm									
ULL2	-1250	57	54	54	52	52	55	57	51	45
	-750	48	45	42	41	41	46	48	38	27
	+750	45	42	40	38	38	43	46	35	25
	+1250	55	52	52	49	49	52	55	49	43

Self-Noise values are shown for a five-square-foot area silencer. For each doubling of the face area add three dB; for each halving of the face area, subtract three dB from the values in Table V.

* Estimated

Quiet-Duct Ultra™ / Low Silencers

Type: ULL3

Low Frequency Silencers with Forward & Reverse Flow Ratings

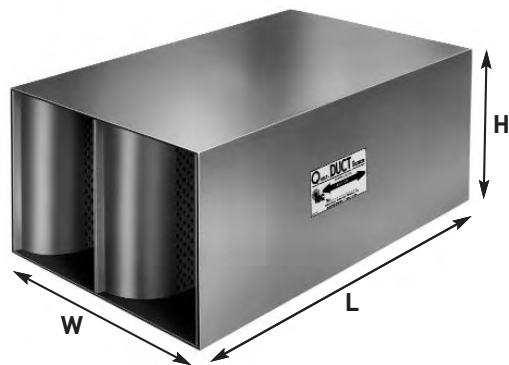

Designating Silencers

Model: 5ULL3-24-18

Type: ULL3 **Length:** 5' **Width:** 24" **Height:** 18"

First introduced back in 2005, these have been designed to optimize Dynamic Insertion Loss performance for frequencies between 25 Hz and 80 Hz. The Quiet-Duct Ultra™/Low silencers offers to the industry, first to be published by IAC, a guaranteed performance data in the 31.5 Hz full octave-band center frequencies.

ULL3 is designed to provide optimization for applications where the Dynamic Insertion Loss performance in more discrete frequencies is required to effectively control narrow-band noise sources, using a finer resolution of the 1/3 Octave Band DIL Data with Static Pressure Drop ratings +/- from 250 – 1250 fpm. All Quiet-Duct Ultra™/Low silencers have been rated with procedures certified in strict accordance with ASTM E477-99 in a NVLAP Accredited Acoustical Laboratory.

Table I: Dynamic Insertion Loss (DIL) Ratings: Forward (+) / Reverse (-) Flow

IAC Model	Octave Band	0	1	2	3	4	5	6	7	8
	Hz	31.5	63	125	250	500	1K	2K	4K	8K
	Face Velocity, fpm	Dynamic Insertion Loss, dB								
3ULL3	-1250	3	8	12	14	13	11	10	8	7
	-1000	3	8	12	14	13	11	10	8	7
	-750	3	8	12	14	13	12	10	8	7
	750	2	7	11	13	14	12	10	8	6
	1000	2	7	11	13	14	13	10	8	6
	1250	2	7	11	13	14	13	10	7	6
5ULL3	-1250	5	11	18	21	19	15	12	10	7
	-1000	5	11	18	21	19	15	12	9	7
	-750	4	11	18	21	19	15	12	9	7
	750	4	10	16	20	20	16	12	9	7
	1000	4	10	16	20	20	16	12	9	7
	1250	4	9	16	19	20	16	12	9	7
7ULL3	-1250	6	14	24	28	25	19	14	10	9
	-1000	6	14	24	28	25	19	14	10	9
	-750	6	14	23	27	25	19	14	10	9
	750	5	12	22	26	25	19	14	9	8
	1000	5	12	21	26	25	19	15	9	8
	1250	5	12	21	25	25	20	15	9	8
10ULL3	-1250	8	19	32	37	34	24	17	14	10
	-1000	8	19	32	37	34	24	17	13	9
	-750	8	18	31	37	34	24	17	13	9
	750	7	16	29	35	33	24	18	13	9
	1000	6	16	28	34	33	24	18	13	9
	1250	6	15	28	34	33	24	18	13	8

(+) Forward Flow / (-) Reverse Flow. Aero-acoustic performance data based on NVLAP accredited laboratory tests conducted in strict accordance with ASTM E477-99. Contact IAC if attenuation in excess of 50 dB is required.

Table II: Weights & Measures*

Nominal Length	W/In H/In	27 12	27 18	27 24	27 30	27 36	27 42	27 48	54 12	54 18	54 24	54 30	54 36	54 42	54 48
3'	Wt/lb.	49	57	66	75	84	93	102	84	98	111	124	138	151	164
5'		80	94	107	121	135	148	162	139	159	179	198	218	238	258
7'		112	130	148	167	185	204	222	193	220	246	273	299	N/A	N/A
10'		159	184	210	236	261	287	312	N/A	N/A	N/A	N/A	N/A	N/A	N/A

*Note: Widths are available from 24" to 36" and from 48" to 54"

Table III: Aerodynamic Performance

Silencer Face Area is the cross-sectional area at the air entering face of the module or bank of modules. The Face Velocity is the CFM of airflow divided by the Face Area (in square feet). Pressure Drop for any face velocity can be calculated from the equation:

$$PD = (\text{Actual FV}/\text{Catalog FV})^2(\text{Catalog PD}).$$

PD values are per ASTM E477 test standard. For the smaller widths available add 15% and subtract 5% for the larger widths available. If silencers are near elbows, transitions or other non-ideal conditions sufficient allowances must be made to account for system effects when calculating the overall silencer pressure loss.

IAC Model	Static Pressure Drop, i.w.g.						
ULL3	3'	0.02	0.09	0.21	0.37	0.58	0.83
	5'	0.02	0.10	0.22	0.40	0.62	0.89
	7'	0.03	0.11	0.24	0.42	0.66	0.96
	10'	0.03	0.12	0.26	0.47	0.73	1.05
Silencer Face Velocity, fpm	250	500	750	1000	1250	1500	

Table IV: 1/3 Octave Band DIL Data

IAC Model	Octave Band	31.5 Hz			63 Hz		
	Hz	25	31.5	40	50	63	80
	Silencer Face Velocity, fpm						
3ULL3	-1250	2	3	4	6	8	10
	-1000	2	3	4	6	8	10
	-750	2	3	4	6	8	10
	750	2	2	3	5	7	9
	1000	2	2	3	5	7	9
	1250	2	2	3	5	7	9
5ULL3	-1250	3	5	6	9	12	15
	-1000	3	5	6	9	12	14
	-750	3	4	6	9	11	14
	750	3	4	5	8	10	13
	1000	3	4	5	8	10	13
	1250	3	3	5	7	10	12
7ULL3	-1250	5	6	9	12	15	19
	-1000	4	6	8	12	15	19
	-750	4	6	8	11	15	18
	750	4	5	7	10	13	17
	1000	3	5	7	10	13	16
	1250	3	5	7	9	13	16
10ULL3	-1250	6	9	12	16	20	25
	-1000	6	9	12	15	20	25
	-750	6	8	11	15	19	24
	750	5	7	10	13	17	22
	1000	5	7	9	13	17	22
	1250	4	6	9	13	17	21

One-Third (1/3) Octave Band data for IAC Quiet-Duct Ultra™/Low silencers is provided for those applications where Dynamic Insertion Loss performance in more discrete frequencies is required to effectively control narrow-band noise sources. Table IV presents the 1/3 Octave Band DIL components that combine to comprise the Full Octave Band DIL values.

Table V: Self-Noise Power Levels, dB re: 10-12 Watts

IAC Model	Octave Band	0	1	2	3	4	5	6	7	8
	Hz	31.5'	63	125	250	500	1K	2K	4K	8K
	Silencer Face Velocity, fpm									
ULL3	-1250	58	55	56	53	53	56	58	52	47
	-750	49	46	43	42	42	47	49	39	28
	+750	45	42	40	38	38	43	46	35	25
	+1250	55	52	52	49	49	52	55	49	43

Self-Noise values are shown for a five-square-foot area silencer. For each doubling of the face area add three dB; for each halving of the face area, subtract three dB from the values in Table V.

* Estimated

Quiet-Duct Ultra™ / Green Silencers

Section 15000 Specifications

1.01 General

- A. Furnish and install "Quiet-Duct Ultra™/Green" (rectangular) silencers of the types and sizes shown on the plans and/or listed in the schedule. Silencers shall be the product of Industrial Acoustics Company. Any specification change must be submitted in writing and approved by the Architect/Engineer, in writing, at least 10 days prior to the bid due-date.

2.01 Materials

- A. Outer casings of rectangular silencers shall be made of 22 gauge type #G-90 lock-former-quality galvanized steel.
- B. Interior partitions for rectangular silencers shall be not less than 26 gauge type #G-90 galvanized lock-former-quality perforated steel.
- C. Acoustic fill material shall be 100% environmentally friendly, and constructed of recycled natural fibers. Each fiber shall be treated with an EPA registered fungal inhibitor in order to prevent mold, mildew, fungi, and pest protection. The fill material must not contain any harmful chemicals, irritants, and/or volatile organic compounds (VOCs) in order to prevent off-gassing.
- D. Combustion ratings for the silencer acoustic fill shall be not greater than the following when tested to ASTM E 84, NFPA Standard 255, or UL No. 723:

Flamespread Classification	5
Smoke Development Rating.....	35

3.01 Construction

- A. Units shall be constructed in accordance with the ASHRAE Guide recommendations for high pressure duct work. Seams shall be lock formed and mastic filled. Rectangular casing seams shall be in the corners of the silencer shell to provide maximum unit strength and rigidity. Interior partitions shall be fabricated from single-piece, margin-perforated sheets and shall have die-formed entrance and exit shapes so as to provide the maximum aerodynamic efficiency and minimum self-noise characteristics in the sound attenuator. Blunt noses or squared off partitions will not be accepted.
- B. Attachment of the interior partitions to the casing shall be by means of an interlocking track assembly. Tracks shall be solid galvanized steel and shall be welded to the outer casing. Attachment of the interior partitions to the tracks shall be such that a minimum of 4 thicknesses of metal exist at this location. The track assembly shall stiffen the exterior casing, provide a reinforced attachment detail for the interior partitions, and shall maintain a uniform airspace width along the length of the silencer for consistent aerodynamic and acoustic performance. Interior partitions shall be additionally secured to the outer casing with welded nose clips at both ends of the sound attenuator.

- C. Sound attenuating units shall not fail structurally when subjected to a differential air pressure of 8 inches water gauge from inside to outside the casing. Airtight construction shall be provided by use of a duct sealing compound on the jobsite material and labor furnished by the contractor.

4.01 Acoustic Performance

- A. All silencer ratings shall be determined in a duct-to-reverberant room test facility which provides for airflow in both directions through the test silencer in accordance with ASTM Specification E477-99. The test facility shall be NVLAP accredited for the ASTM E477-99 test standard. Data from a non-accredited laboratory will not be acceptable. The test set-up and procedure shall be such that all effects due to end reflection, directivity, flanking transmission, standing waves and test chamber sound absorption are eliminated.

Acoustic ratings shall include Dynamic Insertion Loss (DIL) and Self-Noise (SN) Power Levels both for FORWARD FLOW (air and noise in same direction) and REVERSE FLOW (air and noise in opposite directions) with airflow of at least 2000 fpm entering face velocity. Data for rectangular and tubular type silencers shall be presented for tests conducted using silencers no smaller than the following cross-sections:

Rectangular, inch: 24 x 24, 24 x 30, or 24 x 36
Tubular, inch: 12, 24, 36 and 48

5.01 Aerodynamic Performance

- A. Static pressure loss of silencers shall not exceed those listed in the silencer schedule as the airflow indicates. Airflow measurements shall be made in accordance with ASTM specification E477-99 and applicable portions of ASME, AMCA, and ADC airflow test codes. Tests shall be reported on the identical units for which acoustic data is presented.

6.01 Certification

- A. With submittals, the manufacturer shall supply certified test data on Dynamic Insertion Loss, Self-Noise Power Levels, and Aerodynamic Performance for Reverse and Forward Flow test conditions. Test data shall be for a standard product. All rating tests shall be conducted in the same facility, shall utilize the same silencer, and shall be open to inspection upon request from the Architect/Engineer.

7.01 Duct Transitions

- A. When transitions are required to adapt silencer dimensions to connecting duct work they shall be furnished by the installing contractor.

Quiet-Duct Ultra™ / Green Silencers

Introduction

Environmentally Sound Silencers with Forward & Reverse Flow Ratings

The Ultra™/Green Quiet-Duct Series complements the traditional Commercial Series Silencers, but instead of using fiberglass or mineral wool insulation as the infill material, Ultra™/Green Quiet-Duct Series line of silencers have been designed and developed in response to the trend for environmentally friendly building projects and products. This 100% environmentally friendly attenuation solution uses recycled cotton-fiber based acoustic fill material and delivers performance that meets or exceeds that of a standard Quiet-Duct silencer. They still have the necessary flame-/smoke-spread ratings they also inhibit the growth of mold, which is a significant concern in many interior environments needing this specific type of application. All Ultra™/Green Quiet-Duct silencers have been rated with procedures certified in strict accordance with ASTM E477-99 in a NVLAP Accredited Acoustical Laboratory.



QUIET-DUCT ULTRA™ / GREEN SILENCER TYPES:

- UGLFS
- UGLFM
- UGLFL
- UGS
- UGMS
- UGML
- UGL

Quiet-Duct Ultra™ / Green Silencers

Type: UGLFS

Environmentally Sound Silencers with Forward & Reverse Flow Ratings

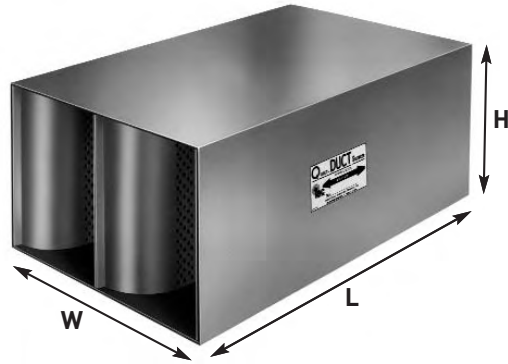

Designating Silencers

Model: 5UGLFS-24-18

Type: UGLFS **Length:** 5' **Width:** 24" **Height:** 18"

The IAC Type UGLFS Quiet-Duct Ultra™/Green Silencers provide that same superior low frequency attenuation, now with a 100% environmentally friendly attenuation solution which uses recycled acoustic fill material, instead of fiberglass. All UGLFS Silencers have been rated and certified with procedures certified in accordance with applicable portions of ASTM E4777. All Dynamic Insertion Loss and Self-Noise Acoustic Performance data were obtained in a NVLAP Accredited Acoustical Laboratory. Like the standard LFS, the UGLFS is still advantageous where low frequency DIL requirements are high in HVAC systems. In some systems, high frequency attenuation may be provided by the system components or may not be needed.

Table I: Dynamic Insertion Loss (DIL) Ratings: Forward (+) / Reverse (-) Flow

IAC Model	Octave Band	1	2	3	4	5	6	7	8
	Hz	63	125	250	500	1K	2K	4K	8K
	Face Velocity, fpm	Dynamic Insertion Loss, dB							
3UGLFS	-2000	6	13	25	32	28	20	17	14
	-1000	6	12	24	32	27	20	19	14
	0	5	12	24	32	28	21	19	14
	1000	6	11	22	30	27	21	18	14
	2000	5	9	20	29	26	20	18	14
5UGLFS	-2000	11	23	39	46	44	27	24	19
	-1000	11	22	36	45	44	29	25	18
	0	10	20	35	43	43	29	24	17
	1000	10	17	31	40	41	28	22	14
	2000	9	14	29	38	39	29	20	14
7UGLFS	-2000	12	27	43	50	49	33	21	18
	-1000	12	23	43	48	49	36	25	17
	0	10	24	40	45	46	32	23	16
	1000	10	22	35	42	43	29	20	17
	2000	10	23	37	45	44	28	19	16
10UGLFS	-2000	16	32	48	52	52	43	24	18
	-1000	15	31	52	51	54	45	30	19
	0	16	30	51	52	54	47	32	20
	1000	14	26	48	54	53	49	33	24
	2000	13	24	47	56	55	49	36	26

(+) Forward Flow / (-) Reverse Flow. Aero-acoustic performance data based on NVLAP accredited laboratory tests conducted in strict accordance with ASTM E477-99. Contact IAC if attenuation in excess of 50 dB is required.

Table II: Weights & Measures

Nominal Length	W/In H/In	6	6	6	6	6	6	12	12	12	12	12	12	24	24	24
3'	Wt/lb.	18	21	25	29	31	35	35	42	50	57	61	70	54	64	74
5'		29	35	42	47	52	59	58	70	83	94	104	117	89	104	121
7'		41	49	59	67	75	83	82	98	118	134	150	166	125	146	175
10'		59	70	84	95	N/A	N/A	117	140	167	190	N/A	N/A	178	209	250

Nominal Length	W/In H/In	24	24	24	36	36	36	36	36	36	48	48	48	48	48	48
3'	Wt/lb.	82	92	102	89	106	124	139	153	172	108	128	148	164	184	204
5'		136	152	157	147	174	204	230	256	274	178	208	242	272	304	314
7'		196	218	240	207	244	293	330	N/A	N/A	N/A	N/A	N/A	N/A	N/A	N/A
10'		280	N/A	N/A	295	349	417	470	N/A	N/A	N/A	N/A	N/A	N/A	N/A	N/A

Table III: Aerodynamic Performance

IAC Model	L/Ft	Static Pressure Drop, i.w.g.															
UGLFS	3'	0.04	0.05	0.07	0.09	0.11	0.14	0.17	0.20	0.24	0.28	0.32	0.36	0.41	0.46	0.51	0.57
	5'	0.04	0.06	0.08	0.10	0.13	0.16	0.19	0.22	0.26	0.31	0.35	0.40	0.45	0.51	0.56	0.62
	7'	0.04	0.06	0.08	0.10	0.13	0.16	0.20	0.23	0.28	0.32	0.37	0.42	0.47	0.53	0.59	0.65
	10'	0.04	0.06	0.09	0.11	0.14	0.18	0.21	0.26	0.30	0.35	0.40	0.45	0.51	0.57	0.64	0.71
Silencer Face Velocity, fpm		250	300	350	400	450	500	550	600	650	700	750	800	850	900	950	1000

Table IV: Self-Noise Power Levels, dB re: 10-12 Watts

IAC Model	Octave Band	1	2	3	4	5	6	7	8
	Hz	63	125	250	500	1K	2K	4K	8K
	Silencer Face Velocity, fpm								
UGLFS (all sizes)	-2000	58	54	58	61	62	62	65	63
	-1500	51	49	53	56	56	59	60	53
	-1000	45	42	45	43	45	49	44	37
	1000	46	42	45	43	45	49	44	37
	1500	56	54	57	56	52	56	57	51
	2000	68	64	65	66	61	61	64	61

(+) Forward Flow / (-) Reverse Flow. Aero-acoustic performance data based on NVLAP accredited laboratory tests conducted in strict accordance with ASTM E477-99.

TAKE NOTE!

- Silencer Face Area is the cross-sectional area at the silencer entrance
- Face Velocity is the CFM of airflow divided by the Face Area (in sq. ft.)
- Pressure Drop for any velocity can be calculated from this equation:
 $PD = (Actual\ FV/Catalog\ FV)^2 \times (Catalog\ PD)$
- Self Noise values shown are for a four-square-foot face area silencer
- For each doubling of the face area add 3 dB to the self-noise values listed
- For each halving of the face area subtract 3 dB from the self-noise values listed
- Weights and measures are listed for limited number of available sizes

Quiet-Duct Ultra™ / Green Silencers

Type: UGLFM

Environmentally Sound Silencers with Forward & Reverse Flow Ratings



The IAC Type UGLFM Quiet-Duct Ultra™/Green Silencers come with a 100% environmentally friendly attenuation solution which uses recycled acoustic fill material, instead of fiberglass. The UGLFM also provides the same improved low frequency attenuation particularly in the third octave band. When the third band performance is critical, a Type UGLFM Quiet Duct Ultra-Green selection often results in a shorter silencer length than other equivalent silencer models. Type UGLFM Quiet-Duct Ultra™/Green Silencers have been rated with procedures certified in accordance with applicable portions of ASTM E477. All Dynamic Insertion Loss and Self-Noise Acoustic Performance Data were obtained in a NVLAP Accredited Acoustical Laboratory. Type UGLFM Silencers are advantageous where low frequency, particularly in the third octave band, DIL requirements are high in HVAC systems.

Designating Silencers

Model: 5UGLFM-24-18

Type: UGLFM **Length:** 5' **Width:** 24" **Height:** 18"

Table I: Dynamic Insertion Loss (DIL) Ratings: Forward (+) / Reverse (-) Flow

IAC Model	Octave Band	1	2	3	4	5	6	7	8
	Hz	63	125	250	500	1K	2K	4K	8K
	Face Velocity, fpm	Dynamic Insertion Loss, dB							
3UGLFM	-2000	5	9	17	24	20	13	14	12
	-1000	4	8	17	25	20	14	15	11
	0	3	8	16	24	20	14	14	10
	1000	2	6	14	22	18	13	12	10
	2000	2	6	14	22	18	12	12	10
5UGLFM	-2000	6	17	28	37	31	16	18	16
	-1000	6	15	27	37	31	18	21	15
	0	6	14	27	36	31	18	19	14
	1000	6	12	24	34	30	18	15	10
	2000	5	10	23	32	30	18	15	9
7UGLFM	-2000	10	21	35	44	38	20	16	16
	-1000	9	19	33	42	40	22	20	15
	0	9	19	32	42	40	22	19	14
	1000	9	15	29	43	39	23	18	16
	2000	8	14	28	42	40	23	18	16
10UGLFM	-2000	13	26	43	51	49	25	19	17
	-1000	12	23	42	50	50	28	24	17
	0	13	23	41	51	51	28	23	16
	1000	12	20	39	52	51	29	22	17
	2000	11	19	37	52	52	29	22	19

(+) Forward Flow / (-) Reverse Flow. Aero-acoustic performance data based on NVLAP accredited laboratory tests conducted in strict accordance with ASTM E477-99. Contact IAC if attenuation in excess of 50 dB is required.

Table II: Weights & Measures

Nominal Length	W/In H/In	6	6	6	6	6	6	12	12	12	12	12	12	24	24	24
3'	Wt/lb.	18	21	25	29	31	35	35	42	50	57	61	70	54	64	74
5'		29	35	42	47	52	59	58	70	83	94	104	117	89	104	121
7'		41	49	59	67	75	83	82	98	118	134	150	166	125	146	175
10'		59	70	84	95	N/A	N/A	117	140	167	190	N/A	N/A	178	209	250

Nominal Length	W/In H/In	24	24	24	36	36	36	36	36	36	48	48	48	48	48	48
3'	Wt/lb.	82	92	102	89	106	124	139	153	172	108	128	148	164	184	204
5'		136	152	157	147	174	204	230	256	274	178	208	242	272	304	314
7'		196	218	240	207	244	293	330	N/A	N/A	N/A	N/A	N/A	N/A	N/A	N/A
10'		280	N/A	N/A	295	349	417	470	N/A	N/A	N/A	N/A	N/A	N/A	N/A	N/A

Table III: Aerodynamic Performance

IAC Model	L/Ft	Static Pressure Drop, i.w.g.															
UGLFM	3'	0.05	0.07	0.09	0.12	0.15	0.19	0.23	0.27	0.32	0.37	0.42	0.48	0.55	0.61	0.68	0.76
	5'	0.05	0.07	0.10	0.13	0.16	0.20	0.24	0.29	0.34	0.39	0.45	0.51	0.57	0.64	0.72	0.79
	7'	0.05	0.07	0.10	0.13	0.17	0.21	0.25	0.30	0.35	0.41	0.47	0.53	0.60	0.67	0.75	0.83
	10'	0.06	0.08	0.12	0.15	0.19	0.24	0.29	0.34	0.40	0.46	0.53	0.60	0.68	0.76	0.85	0.94
Silencer Face Velocity, fpm		500	600	700	800	100	1000	1100	1200	1300	1400	1500	1600	1700	1800	1900	2000

Table IV: Self-Noise Power Levels, dB re: 10-12 Watts

IAC Model	Octave Band	1	2	3	4	5	6	7	8
	Hz	63	125	250	500	1K	2K	4K	8K
	Silencer Face Velocity, fpm								
UGLFM (all sizes)	-3000	64	62	64	66	65	64	66	62
	-2000	53	50	54	56	56	59	58	51
	-1000	42	40	43	45	47	46	37	27
	1000	47	34	36	35	40	37	27	20
	2000	54	52	58	56	51	56	55	50
	3000	68	64	64	63	61	63	66	63

(+) Forward Flow / (-) Reverse Flow. Aero-acoustic performance data based on NVLAP accredited laboratory tests conducted in strict accordance with ASTM E477-99.

TAKE NOTE!

- Silencer Face Area is the cross-sectional area at the silencer entrance
- Face Velocity is the CFM of airflow divided by the Face Area (in sq. ft.)
- Pressure Drop for any velocity can be calculated from this equation:
 $PD = (Actual\ FV/Catalog\ FV)^2 \times (Catalog\ PD)$
- Self Noise values shown are for a four-square-foot face area silencer
- For each doubling of the face area add 3 dB to the self-noise values listed
- For each halving of the face area subtract 3 dB from the self-noise values listed
- Weights and measures are listed for limited number of available sizes

Quiet-Duct Ultra™ / Green Silencers

Type: UGLFL

Environmentally Sound Silencers with Forward & Reverse Flow Ratings



The IAC Type UGLFL Quiet-Duct Ultra™ / Green Silencers, along with the 100% environmentally friendly attenuation solution which uses recycled acoustic fill material, instead of fiberglass, still provides that same improved low frequency attenuation as well as low pressure drop aerodynamic performance. When third and fourth band performance is critical at the lowest available pressure drop, a Type UGLFL Quiet-Duct Ultra-Green selection often results in a shorter silencer length than other equivalent silencer models. Type UGLFL Quiet-Duct Ultra™ / Green Silencers have been rated with procedures certified in accordance with applicable portions of ASTM E477. All Dynamic Insertion Loss and Self-Noise Acoustic Performance Data were obtained in a NVLAP Accredited Acoustical Laboratory. Type UGLFL Silencers are advantageous where low frequency acoustic performance and low pressure drop aerodynamic performance are both essential to the HVAC system.

Designating Silencers

Model: 5UGLFL-24-18

Type: UGLFL **Length:** 5' **Width:** 24" **Height:** 18"

Table I: Dynamic Insertion Loss (DIL) Ratings: Forward (+) / Reverse (-) Flow

IAC Model	Octave Band	1	2	3	4	5	6	7	8
	Hz	63	125	250	500	1K	2K	4K	8K
	Face Velocity, fpm	Dynamic Insertion Loss, dB							
3UGLFL	-2000	3	7	15	20	19	11	14	12
	-1000	3	8	14	20	18	12	15	11
	0	3	9	16	23	23	16	14	10
	1000	3	9	16	25	26	20	13	10
	2000	3	8	15	25	25	13	13	10
5UGLFL	-2000	5	12	22	31	31	14	20	16
	-1000	5	12	20	31	30	17	21	15
	0	5	11	20	30	29	16	18	13
	1000	4	8	17	27	26	15	13	9
	2000	4	7	16	27	25	14	13	8
7UGLFL	-2000	8	18	28	38	31	16	16	15
	-1000	7	15	25	37	32	18	18	14
	0	6	15	25	38	32	18	17	13
	1000	6	12	23	39	31	19	16	15
	2000	5	10	20	38	32	18	16	15
10UGLFL	-2000	10	23	34	42	41	18	19	17
	-1000	9	20	33	41	43	21	21	16
	0	9	19	31	43	43	21	20	15
	1000	9	15	28	46	42	22	19	16
	2000	7	13	26	47	43	21	18	16

(+) Forward Flow / (-) Reverse Flow. Aero-acoustic performance data based on NVLAP accredited laboratory tests conducted in strict accordance with ASTM E477-99. Contact IAC if attenuation in excess of 50 dB is required.

Table II: Weights & Measures

Nominal Length	W/In H/In	6	6	6	6	6	6	12	12	12	12	12	12	24	24	24
3'	Wt/lb.	18	21	25	29	31	35	35	42	50	57	61	70	54	64	74
5'		29	35	42	47	52	59	58	70	83	94	104	117	89	104	121
7'		41	49	59	67	75	83	82	98	118	134	150	166	125	146	175
10'		59	70	84	95	N/A	N/A	117	140	167	190	N/A	N/A	178	209	250

Nominal Length	W/In H/In	24	24	24	36	36	36	36	36	36	48	48	48	48	48	48
3'	Wt/lb.	82	92	102	89	106	124	139	153	172	108	128	148	164	184	204
5'		136	152	157	147	174	204	230	256	274	178	208	242	272	304	314
7'		196	218	240	207	244	293	330	N/A	N/A	N/A	N/A	N/A	N/A	N/A	N/A
10'		280	N/A	N/A	295	349	417	470	N/A	N/A	N/A	N/A	N/A	N/A	N/A	N/A

Table III: Aerodynamic Performance

IAC Model	L/Ft	Static Pressure Drop, i.w.g.															
		UGLFL	3'	0.01	0.05	0.08	0.11	0.15	0.19	0.24	0.30	0.36	0.43	0.51	0.59	0.68	0.77
5'	0.01		0.05	0.08	0.12	0.16	0.20	0.26	0.32	0.39	0.46	0.54	0.63	0.72	0.82	0.92	1.04
7'	0.01		0.05	0.09	0.12	0.17	0.22	0.28	0.34	0.41	0.49	0.57	0.67	0.77	0.87	0.98	1.10
10'	0.02		0.06	0.10	0.14	0.19	0.24	0.31	0.38	0.46	0.55	0.64	0.74	0.86	0.97	1.10	1.23
Silencer Face Velocity, fpm		400	800	1000	1200	1400	1600	1800	2000	2200	2400	2600	2800	3000	3200	3400	3600

Table IV: Self-Noise Power Levels, dB re: 10-12 Watts

IAC Model	Octave Band	1	2	3	4	5	6	7	8
	Hz	63	125	250	500	1K	2K	4K	8K
	Silencer Face Velocity, fpm								
UGLFL (all sizes)	-3000	55	54	56	57	56	59	61	56
	-2000	46	45	48	49	50	54	49	42
	-1000	31	30	34	35	40	45	28	20
	1000	32	24	32	25	34	39	24	20
	2000	47	42	46	44	46	51	46	38
	3000	56	53	54	55	53	58	59	53

(+) Forward Flow / (-) Reverse Flow. Aero-acoustic performance data based on NVLAP accredited laboratory tests conducted in strict accordance with ASTM E477-99.

TAKE NOTE!

- Silencer Face Area is the cross-sectional area at the silencer entrance
- Face Velocity is the CFM of airflow divided by the Face Area (in sq. ft.)
- Pressure Drop for any velocity can be calculated from this equation:
 $PD = (Actual\ FV/Catalog\ FV)^2 \times (Catalog\ PD)$
- Self Noise values shown are for a four-square-foot face area silencer
- For each doubling of the face area add 3 dB to the self-noise values listed
- For each halving of the face area subtract 3 dB from the self-noise values listed
- Weights and measures are listed for limited number of available sizes

Quiet-Duct Ultra™ / Green Silencers

Type: UGS

Environmentally Sound Silencers with Forward & Reverse Flow Ratings



Designating Silencers

Model: 5UGS-24-18

Type: UGS **Length:** 5' **Width:** 24" **Height:** 18"

The IAC Type UGS Quiet-Duct Ultra™/Green Silencer for many years has been the industry standard for maximum noise reduction with minimum silencer length. In response to the current trend for environmentally friendly building products, the UGS Quiet-Duct Ultra™/Green Silencers also come with a 100% environmentally friendly attenuation solution which uses recycled acoustic fill material, instead of fiberglass. The IAC Type UGS Quiet-Duct Ultra™/Green Silencers have been rated with procedures certified in accordance with applicable portions of ASTM E477. All Dynamic Insertion Loss and Self-Noise Acoustic Performance Data were obtained in a NVLAP Accredited Acoustical Laboratory.

Table I: Dynamic Insertion Loss (DIL) Ratings: Forward (+) / Reverse (-) Flow

IAC Model	Octave Band	1	2	3	4	5	6	7	8
	Hz	63	125	250	500	1K	2K	4K	8K
	Face Velocity, fpm	Dynamic Insertion Loss, dB							
3UGS	-1500	4	9	18	35	41	36	22	14
	-1000	3	9	17	35	40	36	23	15
	-750	3	8	16	34	41	36	24	16
	750	3	6	14	31	39	35	25	16
	1000	3	6	14	31	39	35	25	16
	1500	3	6	13	29	38	35	25	16
5UGS	-1500	8	15	28	46	47	42	35	21
	-1000	8	14	26	45	46	45	37	22
	-750	8	13	26	45	46	45	37	22
	750	6	10	23	44	46	45	38	23
	1000	6	10	22	43	46	45	38	24
	1500	5	9	21	42	46	45	39	24
7UGS	-1500	12	22	35	48	46	44	39	24
	-1000	11	20	33	47	47	46	44	25
	-750	10	19	33	47	47	46	44	26
	750	7	15	28	48	47	46	44	32
	1000	7	15	27	48	47	46	44	33
	1500	6	14	27	48	48	46	45	34
10UGS	-1500	14	27	43	45	47	46	41	31
	-1000	14	30	42	45	47	46	46	32
	-750	13	27	41	45	47	46	46	33
	750	10	21	40	47	48	46	47	42
	1000	10	21	39	46	48	46	47	43
	1500	9	19	39	47	48	47	46	44

(+) Forward Flow / (-) Reverse Flow. Aero-acoustic performance data based on NVLAP accredited laboratory tests conducted in strict accordance with ASTM E477-99. Contact IAC if attenuation in excess of 50 dB is required.

Table II: Weights & Measures

Nominal Length	W/In H/In	6	6	6	12	12	12	12	12	12	12
3'	Wt/lb.	22	35	49	33	43	52	62	74	83	93
5'		40	63	87	56	73	89	107	125	141	158
7'		55	88	122	78	102	125	150	176	199	226
10'		77	123	171	111	155	177	212	250	N/A	N/A

Nominal Length	W/In H/In	24	24	24	24	24	24	36	36	36	36
3'	Wt/lb.	71	86	102	117	132	147	142	162	182	204
5'		121	147	173	204	230	256	249	284	319	355
7'		170	207	243	288	325	362	N/A	N/A	N/A	N/A
10'		241	293	345	405	N/A	N/A	N/A	N/A	N/A	N/A

Table III: Aerodynamic Performance

Silencer Face Area is the cross-sectional area at the air entering face of the module or bank of modules. The Face Velocity is the CFM of airflow divided by the Face Area (in square feet). Pressure Drop for any face velocity can be calculated from the equation:

$$PD = (\text{Actual FV}/\text{Catalog FV})^2(\text{Catalog PD})$$

IAC Model	Static Pressure Drop, i.w.g.						
UGS	3'	0.88	0.40	0.22	0.25	0.43	0.93
	5'	1.10	0.49	0.25	0.25	0.47	1.08
	7'	1.40	0.61	0.31	0.29	0.54	1.30
	10'	1.98	0.80	0.42	0.40	0.71	1.65
Silencer Face Velocity, fpm	-1500	-1000	-750	750	1000	1500	

Table IV: Self-Noise Power Levels, dB re: 10-12 Watts

IAC Model	Octave Band	1	2	3	4	5	6	7	8
	Hz	63	125	250	500	1K	2K	4K	8K
	Silencer Face Velocity, fpm								
3UGS	-1500	42	49	53	56	57	66	65	46
	-1000	33	41	45	47	51	54	43	32
	-750	34	35	38	41	44	42	29	26
	750	36	36	37	40	45	42	31	25
	1000	38	42	43	45	48	50	42	31
	1500	47	53	52	54	55	57	55	46
5UGS	-1500	41	48	53	56	57	66	65	47
	-1000	35	42	45	47	49	54	41	31
	-750	35	36	38	40	43	39	28	26
	750	31	33	37	38	42	37	26	25
	1000	34	42	44	45	47	48	40	31
	1500	47	54	53	54	53	56	54	46
7UGS	-1500	43	49	54	56	57	63	62	49
	-1000	34	43	46	48	50	54	43	33
	-750	32	37	39	39	44	41	28	26
	750	37	38	38	37	42	39	28	25
	1000	38	45	46	45	46	48	40	30
	1500	50	56	56	57	54	56	56	48
10UGS	-1500	40	46	51	56	57	61	62	49
	-1000	35	40	45	48	49	54	43	34
	-750	35	36	39	41	43	42	30	26
	750	35	39	40	41	44	42	30	25
	1000	38	46	47	47	48	50	43	33
	1500	53	58	58	58	55	58	57	49

Self-Noise values shown are for a four-square-foot area silencer. For each doubling of the face area add three dB; for each halving of the face area, subtract three dB from the values in Table IV.

Quiet-Duct Ultra™ / Green Silencers

Type: UGMS

Environmentally Sound Silencers with Forward & Reverse Flow Ratings

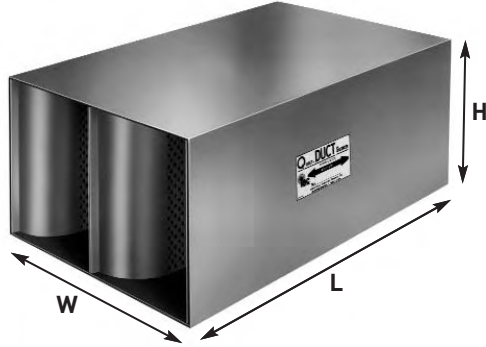

The IAC Type UGMS Quiet-Duct Ultra-Green Silencer provides that same 100% environmentally friendly attenuation solution which uses recycled acoustic fill material, instead of fiberglass, and still provides that same excellent attenuation in the medium velocity range. Type UGMS Quiet-Duct Ultra-Green Silencers have been rated with procedures certified in accordance with applicable portions of ASTM E477. All Dynamic Insertion Loss and Self-Noise Acoustic Performance Data were obtained in a NVLAP Accredited Acoustical Laboratory. The UGMS Quiet-Duct Ultra-Green Silencer is very advantages in that it provides an awesome design flexibility suitable for many different types of applications based on its baffle geometry.

Designating Silencers

Model: 5UGMS-24-18

Type: UGMS **Length:** 5' **Width:** 24" **Height:** 18"

Table I: Dynamic Insertion Loss (DIL) Ratings: Forward (+) / Reverse (-) Flow

IAC Model	Octave Band	1	2	3	4	5	6	7	8
	Hz	63	125	250	500	1K	2K	4K	8K
	Face Velocity, fpm	Dynamic Insertion Loss, dB							
3UGMS	-3000	4	6	13	25	27	19	12	9
	-2000	4	6	13	25	26	17	11	8
	-1000	5	5	12	24	25	18	11	9
	1000	4	5	11	23	24	19	14	10
	2000	4	4	11	21	24	20	15	11
	3000	3	4	10	20	23	21	15	11
5UGMS	-3000	4	11	21	41	42	30	16	11
	-2000	3	10	20	40	45	29	16	11
	-1000	2	9	19	39	43	28	16	9
	1000	2	7	16	37	42	31	20	13
	2000	2	7	15	35	42	31	20	14
	3000	2	7	15	34	42	33	20	14
7UGMS	-3000	4	18	28	43	41	41	21	13
	-2000	4	14	26	47	48	40	21	12
	-1000	3	13	24	47	51	40	20	11
	1000	2	11	21	45	50	43	25	16
	2000	3	10	20	44	50	42	26	16
	3000	2	9	20	44	50	45	28	18
10UGMS	-3000	6	18	33	42	41	44	28	16
	-2000	6	19	35	47	49	47	28	15
	-1000	5	16	32	47	51	50	28	14
	1000	4	14	29	47	51	51	32	19
	2000	4	12	26	47	51	50	34	21
	3000	4	12	25	46	46	46	37	23

(+) Forward Flow / (-) Reverse Flow. Aero-acoustic performance data based on NVLAP accredited laboratory tests conducted in strict accordance with ASTM E477-99. Contact IAC if attenuation in excess of 50 dB is required.

Table II: Weights & Measures

Nominal Length	W/In H/In	7.5	7.5	7.5	7.5	7.5	7.5	15	15	15	15	15	15	30	30	30
		18	24	30	36	42	48	18	24	30	36	42	48	18	24	30
3'	Wt/lb.	26	40	45	51	66	80	47	57	67	80	89	100	80	95	110
5'		46	67	80	91	112	134	80	96	114	134	150	167	135	161	187
7'		65	95	100	129	158	190	112	135	159	193	216	240	188	224	261
10'		90	135	157	180	223	270	159	192	226	273	N/A	N/A	220	319	371

Nominal Length	W/In H/In	30	30	30	45	45	45	45	45	45	60	60	60	60	60	60
		36	42	48	18	24	30	36	42	48	18	24	30	36	42	48
3'	Wt/lb.	130	145	160	127	152	156	177	197	218	160	190	220	260	290	320
5'		22	248	274	215	257	275	310	345	381	270	322	374	44	496	548
7'		310	347	384	300	359	N/A	N/A	N/A	N/A	376	448	522	620	694	768
10'		440	N/A	N/A	N/A	N/A	N/A	N/A	N/A	N/A	440	638	742	880	N/A	N/A

Table III: Aerodynamic Performance

IAC Model	L/Ft	Static Pressure Drop, i.w.g.															
		UGMS	3'	0.06	0.08	0.10	0.12	0.14	0.17	0.20	0.23	0.26	0.29	0.33	0.36	0.40	0.44
5'	0.08		0.10	0.12	0.15	0.17	0.20	0.24	0.27	0.31	0.35	0.39	0.44	0.48	0.53	0.58	0.64
7'	0.10		0.12	0.15	0.18	0.22	0.26	0.30	0.34	0.39	0.44	0.49	0.54	0.60	0.67	0.73	0.80
10'	0.12		0.15	0.19	0.23	0.27	0.31	0.36	0.42	0.48	0.54	0.60	0.67	0.74	0.82	0.90	0.98
Silencer Face Velocity, fpm		800	900	1000	1100	1200	1300	1400	1500	1600	1700	1800	1900	2000	2100	2200	2300

Silencer Face Area is the cross-sectional area at the air entering face of the module or bank of modules. The Face Velocity is the CFM of airflow divided by the Face Area (in square feet). Pressure Drop for any face velocity can be calculated from the equation:

$$PD = (\text{Actual FV}/\text{Catalog FV})^2(\text{Catalog PD})$$

Table IV: Self-Noise Power Levels, dB re: 10-12 Watts

IAC Model	Octave Band	1	2	3	4	5	6	7	8
	Hz	63	125	250	500	1K	2K	4K	8K
	Silencer Face Velocity, fpm								
3UGMS	-3000	46	58	60	64	63	63	65	57
	-2000	35	50	53	56	58	61	56	43
	-1000	36	38	39	44	43	37	25	26
	1000	40	33	30	34	35	32	22	25
	2000	40	45	45	47	48	52	59	40
	3000	49	58	56	57	57	59	60	54
5UGMS	-3000	45	56	59	63	63	64	66	58
	-2000	37	48	53	56	57	61	57	43
	-1000	33	37	40	42	43	39	26	26
	1000	34	32	30	32	35	29	22	25
	2000	36	44	46	46	47	52	48	38
	3000	50	57	56	57	55	59	61	54
7UGMS	-3000	45	60	63	67	66	65	68	60
	-2000	37	53	56	59	58	62	59	46
	-1000	34	39	41	42	43	39	27	26
	1000	36	32	30	32	36	32	23	26
	2000	39	47	47	47	47	53	49	40
	3000	52	59	57	58	56	58	61	54
10UGMS	-3000	46	59	64	66	65	63	67	58
	-2000	38	53	56	58	56	60	57	43
	-1000	35	42	43	43	43	39	27	26
	1000	34	33	36	37	37	31	23	26
	2000	38	49	51	53	52	54	50	41
	3000	53	61	61	62	61	61	62	55

Self-Noise values shown are for a four-square-foot area silencer. For each doubling of the face area add three dB; for each halving of the face area, subtract three dB from the values in Table IV.

Quiet-Duct Ultra™ / Green Silencers

Type: UGML

Environmentally Sound Silencers with Forward & Reverse Flow Ratings

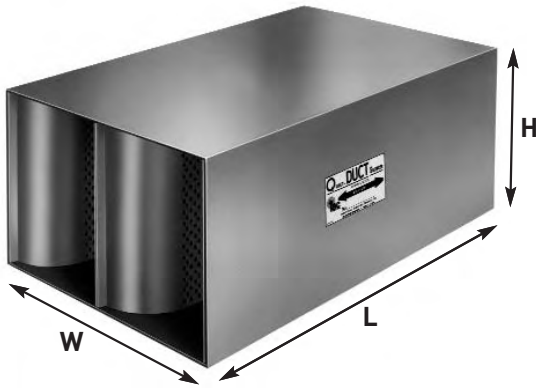

The IAC Type UGML Quiet-Duct Ultra-Green Silencer provides that same 100% environmentally friendly attenuation solution which uses recycled acoustic fill material, instead of fiberglass, and still provides that same excellent attenuation in the medium-to-low velocity ranges. Type UGML Quiet-Duct Ultra-Green Silencers have been rated with procedures certified in accordance with applicable portions of ASTM E477. All Dynamic Insertion Loss and Self-Noise Acoustic Performance Data were obtained in a NVLAP Accredited Acoustical Laboratory.

Designating Silencers

Model: 5UGML-24-18

Type: UGML **Length:** 5' **Width:** 24" **Height:** 18"

Table I: Dynamic Insertion Loss (DIL) Ratings: Forward (+) / Reverse (-) Flow

IAC Model	Octave Band	1	2	3	4	5	6	7	8
	Hz	63	125	250	500	1K	2K	4K	8K
	Face Velocity, fpm	Dynamic Insertion Loss, dB							
3UGML	-3000	3	4	11	21	17	10	7	5
	-2000	2	4	10	21	17	11	7	5
	-1000	4	3	10	21	17	11	8	6
	1000	4	3	8	19	16	11	8	6
	2000	3	3	8	18	16	11	8	7
	3000	2	3	7	17	16	12	9	8
5UGML	-3000	6	8	17	35	30	16	7	4
	-2000	6	7	16	34	29	16	8	4
	-1000	5	7	16	34	29	17	9	5
	1000	4	6	14	32	28	18	10	9
	2000	4	6	13	31	29	18	11	9
	3000	4	5	13	29	29	19	12	10
7UGML	-3000	6	10	21	44	41	24	14	10
	-2000	6	9	20	43	40	23	14	10
	-1000	6	9	20	42	40	23	13	10
	1000	5	7	18	40	39	24	13	10
	2000	5	7	17	38	39	24	13	11
	3000	5	7	16	37	39	24	14	12
10UGML	-3000	7	14	28	44	44	33	17	11
	-2000	7	14	27	48	50	30	17	12
	-1000	7	12	25	47	51	30	14	11
	1000	6	10	23	48	51	30	15	11
	2000	6	10	22	48	51	31	16	12
	3000	6	9	22	48	53	32	17	14

(+) Forward Flow / (-) Reverse Flow. Aero-acoustic performance data based on NVLAP accredited laboratory tests conducted in strict accordance with ASTM E477-99. Contact IAC if attenuation in excess of 50 dB is required.

Table II: Weights & Measures

Nominal Length	W/In H/In	9	9	9	9	9	9	18	18	18	18	18	18	36	36	36
		18	24	30	36	42	48	18	24	30	36	42	48	18	24	30
3'	Wt/lb.	35	41	52	57	65	73	52	61	71	84	94	104	69	103	120
5'		60	71	82	95	107	119	87	103	121	142	158	175	120	175	201
7'		84	100	116	133	150	167	122	144	168	200	223	247	169	246	283
10'		118	141	167	190	240	215	174	203	239	284	N/A	N/A	238	349	403

Nominal Length	W/In H/In	36	36	36	54	54	54	54	54	54	72	72	72	72	72	72
		36	42	48	18	24	30	36	42	48	18	24	30	36	42	48
3'	Wt/lb.	138	153	168	121	164	191	222	247	272	138	206	240	276	306	336
5'		239	265	291	207	278	322	381	423	466	239	350	402	478	530	582
7'		337	374	411	291	390	451	537	597	658	337	492	566	674	748	822
10'		475	N/A	N/A	412	554	642	759	N/A	N/A	475	698	806	950	N/A	N/A

Table III: Aerodynamic Performance

IAC Model	L/Ft	Static Pressure Drop, i.w.g.															
		UGML	3'	0.05	0.07	0.10	0.13	0.16	0.20	0.24	0.28	0.33	0.38	0.44	0.50	0.57	0.64
5'	0.06		0.08	0.12	0.15	0.19	0.24	0.28	0.34	0.40	0.46	0.53	0.60	0.68	0.76	0.85	0.94
7'	0.07		0.11	0.14	0.19	0.24	0.29	0.36	0.42	0.50	0.58	0.66	0.75	0.85	0.95	1.06	1.18
10'	0.09		0.13	0.18	0.23	0.29	0.36	0.44	0.52	0.61	0.71	0.82	0.93	1.05	1.18	1.31	1.45
Silencer Face Velocity, fpm		1000	1200	1400	1600	1800	2000	2200	2400	2600	2800	3000	3200	3400	3600	3800	4000

Silencer Face Area is the cross-sectional area at the air entering face of the module or bank of modules. The Face Velocity is the CFM of airflow divided by the Face Area (in square feet). Pressure Drop for any face velocity can be calculated from the equation:

$$PD = (\text{Actual FV}/\text{Catalog FV})^2(\text{Catalog PD})$$

Table IV: Self-Noise Power Levels, dB re: 10-12 Watts

IAC Model	Octave Band	1	2	3	4	5	6	7	8
	Hz	63	125	250	500	1K	2K	4K	8K
	Silencer Face Velocity, fpm								
3UGML	-3000	42	53	56	60	61	62	61	51
	-2000	33	47	51	55	56	57	50	36
	-1000	31	35	38	43	40	31	22	24
	1000	35	30	30	33	33	26	21	25
	2000	36	41	43	45	48	50	45	35
	3000	44	52	51	53	53	58	58	51
5UGML	-3000	41	59	62	66	61	62	64	51
	-2000	37	50	53	55	55	58	48	36
	-1000	34	37	37	40	39	30	22	25
	1000	33	32	32	35	35	26	22	24
	2000	34	44	46	48	49	51	45	36
	3000	44	53	55	57	56	60	59	52
7UGML	-3000	42	54	58	62	61	62	62	52
	-2000	38	48	52	55	55	57	50	38
	-1000	35	36	40	43	41	33	22	25
	1000	34	28	27	28	31	23	24	27
	2000	35	41	41	42	45	49	43	32
	3000	45	52	51	52	51	57	57	49
10UGML	-3000	42	57	61	65	63	62	64	54
	-2000	36	50	53	56	55	58	50	39
	-1000	35	38	38	40	39	30	22	24
	1000	33	30	27	28	30	21	21	24
	2000	35	40	40	42	45	50	43	33
	3000	47	53	51	52	51	57	58	51

Self-Noise values shown are for a four-square-foot area silencer. For each doubling of the face area add three dB; for each halving of the face area, subtract three dB from the values in Table IV.

Quiet-Duct Ultra™ / Green Silencers

Type: UGL

Environmentally Sound Silencers with Forward & Reverse Flow Ratings



The IAC Type UGL Quiet-Duct Ultra™ / Green Silencers, has the 100% environmentally friendly attenuation solution which uses recycled acoustic fill material, instead of fiberglass and still provides that same improved lower frequency attenuation and aerodynamic performance as well. Type UGL Quiet-Duct Ultra™ / Green Silencers have been rated with procedures certified in accordance with applicable portions of ASTM E477. All Dynamic Insertion Loss and Self-Noise Acoustic Performance Data were obtained in a INVLAP Accredited Acoustical Laboratory. Type UGL Silencers are advantageous where low frequency acoustic performance is essential to the HVAC system.

Designating Silencers

Model: 5UGL-24-18

Type: UGL **Length:** 5' **Width:** 24" **Height:** 18"

Table I: Dynamic Insertion Loss (DIL) Ratings: Forward (+) / Reverse (-) Flow

IAC Model	Octave Band	1	2	3	4	5	6	7	8
	Hz	63	125	250	500	1K	2K	4K	8K
	Face Velocity, fpm	Dynamic Insertion Loss, dB							
3UGL	-3000	1	5	9	16	21	18	10	7
	-2000	1	5	9	15	20	18	10	7
	-1000	1	4	8	15	19	18	10	7
	1000	1	4	7	14	18	19	11	8
	2000	1	4	7	13	18	19	11	8
	3000	1	4	7	13	17	19	12	8
5UGL	-3000	3	9	15	26	35	31	14	8
	-2000	4	8	14	25	33	31	14	9
	-1000	3	7	13	24	33	31	14	9
	1000	3	6	12	23	30	31	15	12
	2000	2	6	11	22	29	31	16	11
	3000	3	5	11	21	28	31	17	11
7UGL	-3000	3	13	19	35	40	38	17	10
	-2000	4	10	18	34	41	39	16	10
	-1000	4	9	17	32	40	38	16	10
	1000	3	8	14	30	38	39	18	12
	2000	3	8	14	29	37	39	19	12
	3000	2	7	14	28	35	39	20	12
10UGL	-3000	5	18	28	47	44	42	21	11
	-2000	7	14	25	45	47	46	21	11
	-1000	7	12	23	43	47	46	21	12
	1000	7	10	21	41	48	47	23	16
	2000	6	10	20	40	47	47	25	17
	3000	5	10	19	39	47	47	27	18

(+) Forward Flow / (-) Reverse Flow. Aero-acoustic performance data based on NVLAP accredited laboratory tests conducted in strict accordance with ASTM E477-99. Contact IAC if attenuation in excess of 50 dB is required.

Table II: Weights & Measures

Nominal Length	W/In	6	12	12	12	12	12	12	12
	H/In	12	12	18	24	30	36	42	48
3'	Wt/lb.	24	33	43	52	62	74	83	93
5'		41	56	73	89	107	125	141	158
7'		59	78	102	125	150	176	199	266
10'		81	111	155	177	212	250	N/A	N/A

Nominal Length	W/In	24	24	24	24	24	24	36	36	36	36	36	48	48	48	48
	H/In	18	24	30	36	42	48	24	30	36	42	48	30	36	42	48
3'	Wt/lb.	71	86	102	117	132	147	121	143	163	184	205	182	209	235	261
5'		121	147	173	204	230	256	211	245	279	312	346	312	353	395	438
7'		170	207	243	288	325	362	286	351	398	445	492	N/A	N/A	N/A	N/A
10'		241	293	345	405	N/A	N/A	N/A	N/A	N/A	N/A	N/A	N/A	N/A	N/A	N/A

Table III: Aerodynamic Performance

Silencer Face Area is the cross-sectional area at the air entering face of the module or bank of modules. The Face Velocity is the CFM of airflow divided by the Face Area (in square feet). Pressure Drop for any face velocity can be calculated from the equation:

$$PD = (\text{Actual FV}/\text{Catalog FV})^2(\text{Catalog PD})$$

IAC Model	Static Pressure Drop, i.w.g.						
	UGL	3'	0.48	0.21	0.05	0.06	0.25
5'		0.60	0.26	0.06	0.07	0.27	0.64
7'		0.75	0.30	0.07	0.08	0.30	0.72
10'		0.99	0.41	0.10	0.09	0.35	0.83
Silencer Face Velocity, fpm		-3000	-2000	-1000	1000	2000	3000

Table IV: Self-Noise Power Levels, dB re: 10-12 Watts

IAC Model	Octave Band	1	2	3	4	5	6	7	8
	Hz	63	125	250	500	1K	2K	4K	8K
	Silencer Face Velocity, fpm								
3UGL	-3000	50	55	58	61	64	69	66	52
	-2000	37	49	53	56	61	61	48	34
	-1000	38	34	38	41	41	31	23	26
	1000	33	30	33	36	36	28	23	26
	2000	41	45	47	49	52	52	45	32
	3000	62	64	58	59	60	61	59	50
5UGL	-3000	48	53	55	58	62	65	64	52
	-2000	36	46	51	53	59	60	50	35
	-1000	34	35	37	40	42	31	23	26
	1000	34	30	29	32	33	24	24	25
	2000	35	43	43	43	49	50	42	30
	3000	48	54	54	54	56	59	57	49
7UGL	-3000	48	54	56	59	63	69	66	52
	-2000	42	46	52	53	60	60	48	35
	-1000	33	31	34	38	41	30	23	26
	1000	32	31	30	33	34	23	22	26
	2000	36	45	45	45	50	52	43	31
	3000	54	56	56	56	57	61	59	50
10UGL	-3000	51	54	55	57	61	66	64	52
	-2000	37	47	51	52	58	59	48	37
	-1000	34	32	35	39	40	29	23	26
	1000	32	28	26	31	32	22	23	26
	2000	35	44	44	43	49	50	41	30
	3000	52	56	56	55	55	60	57	49

Self-Noise values shown are for a four-square-foot area silencer. For each doubling of the face area add three dB; for each halving of the face area, subtract three dB from the values in Table IV.

Quiet-Duct Ultra™ / ZAPD Silencers

Section 15000 Specifications

1.01 General

- A. Furnish and install "Quiet-Duct Ultra™/ZAPD" (rectangular) silencers of the types and sizes shown on the plans and/or listed in the schedule. Silencers shall be the product of IAC Acoustics. Any specification change must be submitted in writing and approved by the Architect/Engineer, in writing, at least 10 days prior to the bid due-date.

2.01 Materials

- A. Outer casings of rectangular silencers shall be made of 22 gauge type #G-90 lock-former-quality galvanized steel.
- B. Interior partitions for rectangular silencers shall be not less than 26 gauge type #G-90 galvanized lock-former-quality perforated steel.
- C. Filler material shall be inorganic glass fiber of a proper density to obtain the specified acoustic performance and be packed under not less than 5% compression to eliminate voids due to vibration and settling. Material shall be inert, vermin- and moisture-proof.
- D. Combustion ratings for the silencer acoustic fill shall be not greater than the following when tested to ASTM E 84, NFPA Standard 255, or UL No. 723:

Flamespread Classification	20
Smoke Development Rating.....	20

3.01 Construction

- A. Units shall be constructed in accordance with the ASHRAE Guide recommendations for high pressure duct work. Seams shall be lock formed and mastic filled. Rectangular casing seams shall be in the corners of the silencer shell to provide maximum unit strength and rigidity. Interior partitions shall be fabricated from single-piece, margin-perforated sheets and shall have die-formed entrance and exit shapes so as to provide the maximum aerodynamic efficiency and minimum self-noise characteristics in the sound attenuator. Blunt noses or squared off partitions will not be accepted.
- B. Sound attenuating units shall not fail structurally when subjected to a differential air pressure of 8 inches water gauge from inside to outside the casing. Airtight construction shall be provided by use of a duct sealing compound on the job-site material and labor furnished by the contractor.

4.01 Acoustic Performance

- A. All silencer ratings shall be determined in a duct-to-reverberant room test facility which provides for airflow in both directions through the test silencer in accordance with ASTM Specification E477-99. The test facility shall be NVLAP accredited for the ASTM E477-99 test standard. Data from a non-accredited laboratory will not be acceptable. The test set-up and procedure shall be such that all effects due to end reflection, directivity, flanking transmission, standing waves and test chamber sound absorption are eliminated.

Acoustic ratings shall include Dynamic Insertion Loss (DIL) and Self-Noise (SN) Power Levels both for FORWARD FLOW (air and noise in same direction) and REVERSE FLOW (air and noise in opposite directions) with airflow of at least 2000 fpm entering face velocity. Data for rectangular and tubular type silencers shall be presented for tests conducted using silencers no smaller than the following cross-sections:

Rectangular, inch: 24 x 24, 24 x 30, or 24 x 36

5.01 Aerodynamic Performance

- A. IAC Quiet-Duct Ultra™ /ZAPD silencers do not introduce any additional pressure drop into the system.

6.01 Certification

- A. With submittals, the manufacturer shall supply certified test data on Dynamic Insertion Loss, Self-Noise Power Levels, and Aerodynamic Performance for Reverse and Forward Flow test conditions. Test data shall be for a standard product. All rating tests shall be conducted in the same facility, shall utilize the same silencer, and shall be open to inspection upon request from the Architect/Engineer.

7.01 Duct Transitions

- A. When transitions are required to adapt silencer dimensions to connecting duct work they shall be furnished by the installing contractor.

Quiet-Duct Ultra™ / ZAPD Silencers

Type: Z6A

Forward & Reverse Flow Ratings

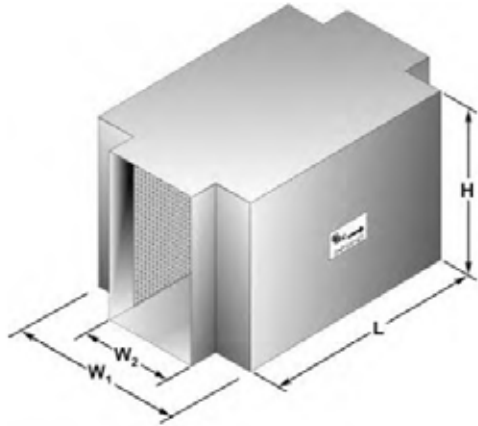

Designating Silencers

Model: 5Z6A 6 x 12

Type: Z6A **Length:** 5' **W₂:** 6" **Height:** 12"

All Z6A Silencers W₁ = 12"

This specific line of silencers has been designed for applications in which acoustics attenuation is required and no allowance can be made for pressure drop loss. A Zero Added Pressure Drop silencer is ideal for high velocity systems or systems that have little or no room for additional pressure drop. The IAC Quiet-Duct ZAPD series of silencers do not create any additional pressure drop in the system and have negligible Self-Noise Sound Power Levels. All Quiet-Duct Ultra™/ZAPD silencers have been rated with procedures certified in strict accordance with ASTM E477-99 in a NVLAP Accredited Acoustical Laboratory.

IAC Quiet-Duct Ultra™/ZAPD silencers have negligible Self Noise Sound Power levels. The Z6A has a 6" wide opening and two 3" baffles on each side, having a combined total width of 12", for effective acoustic attenuation.

Table I: Dynamic Insertion Loss (DIL) Ratings: Forward (+) / Reverse (-) Flow

Silencer Length (ft)	Octave Band	1	2	3	4	5	6	7	8
	Hz	63	125	250	500	1K	2K	4K	8K
	Face Velocity, fpm	Dynamic Insertion Loss, dB							
3	-2000	1	3	7	14	9	10	4	4
	-1000	1	3	7	14	9	11	5	4
	0	1	3	7	14	8	12	6	4
	1000	1	3	7	14	7	13	7	4
	2000	1	3	6	14	8	13	7	4
5	-2000	1	5	13	26	22	20	10	7
	-1000	1	5	12	26	23	19	12	8
	0	1	5	12	26	23	21	12	7
	1000	1	5	12	26	23	22	12	6
	2000	2	5	12	26	23	22	12	7
7	-2000	2	7	17	36	29	27	13	10
	-1000	2	7	17	36	30	28	15	11
	0	2	7	17	36	29	29	16	10
	1000	2	7	16	36	29	31	17	9
	2000	2	7	16	36	30	31	17	9
10	-2000	4	10	24	50	37	37	17	13
	-1000	4	10	24	50	38	38	20	16
	0	4	10	23	49	36	41	22	14
	1000	4	10	23	49	35	43	24	12
	2000	4	10	22	49	36	43	24	13

(+) Forward Flow / (-) Reverse Flow. Aero-acoustic performance data based on NVLAP accredited laboratory tests conducted in strict accordance with ASTM E477-99. Contact IAC if attenuation in excess of 50 dB is required.

Quiet-Duct Ultra™ / ZAPD Silencers

Type: Z6B

Forward & Reverse Flow Ratings

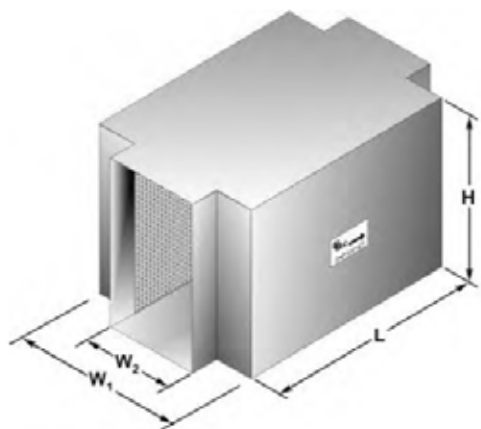

Designating Silencers

Model: 5Z6C 6x12

Type: Z6B **Length:** 5' **W₂:** 6" **Height:** 12"

All Z6B Silencers W₁ = 15"

This specific line of silencers has been designed for applications in which acoustics attenuation is required and no allowance can be made for pressure drop loss. A Zero Added Pressure Drop silencer is ideal for high velocity systems or systems that have little or no room for additional pressure drop. The IAC Quiet-Duct ZAPD series of silencers do not create any additional pressure drop in the system and have negligible Self-Noise Sound Power Levels. All Quiet-Duct Ultra™/ZAPD silencers have been rated with procedures certified in strict accordance with ASTM E477-99 in a NVLAP Accredited Acoustical Laboratory.

IAC Quiet-Duct Ultra™/ZAPD silencers have negligible Self Noise Sound Power levels. The Z6B has a 6" wide opening and two 4.5" baffles on each side, having a combined total width of 15", for effective acoustic attenuation.

Table I: Dynamic Insertion Loss (DIL) Ratings: Forward (+) / Reverse (-) Flow

Silencer Length (ft)	Octave Band	1	2	3	4	5	6	7	8
	Hz	63	125	250	500	1K	2K	4K	8K
	Face Velocity, fpm	Dynamic Insertion Loss, dB							
3	-2000	2	5	9	12	9	11	5	4
	-1000	2	5	9	13	9	11	5	4
	0	2	5	9	13	8	12	6	4
	1000	2	5	9	13	7	13	7	3
	2000	2	4	9	13	8	13	7	4
5	-2000	4	9	18	25	22	20	11	8
	-1000	4	9	18	25	23	19	12	9
	0	3	8	17	25	23	21	12	8
	1000	3	8	17	25	23	22	12	6
	2000	3	8	17	25	23	22	12	7
7	-2000	5	13	25	35	29	27	14	10
	-1000	5	12	25	35	30	28	16	12
	0	5	12	24	35	29	29	16	10
	1000	5	11	24	35	29	31	17	9
	2000	4	11	24	35	29	31	17	9
10	-2000	8	18	33	46	37	38	18	14
	-1000	7	17	33	46	38	39	21	16
	0	7	16	33	47	36	41	22	14
	1000	7	16	33	47	35	43	23	12
	2000	6	15	33	47	35	43	24	13

(+) Forward Flow / (-) Reverse Flow. Aero-acoustic performance data based on NVLAP accredited laboratory tests conducted in strict accordance with ASTM E477-99. Contact IAC if attenuation in excess of 50 dB is required.

Quiet-Duct Ultra™ / ZAPD Silencers

Type: Z6C

Forward & Reverse Flow Ratings

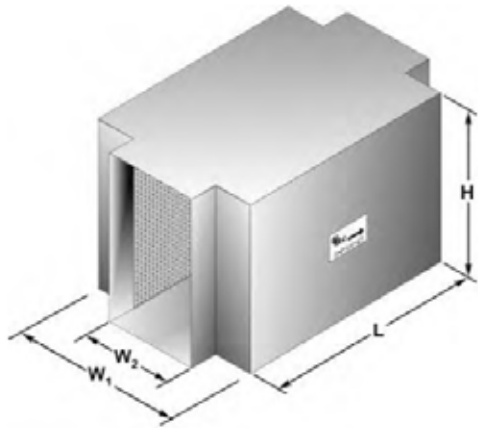

Designating Silencers

Model: 5Z6C 6 x 12

Type: Z6C **Length:** 5' **W₂:** 6" **Height:** 12"

All Z6C Silencers W₁ = 20"

This specific line of silencers has been designed for applications in which acoustics attenuation is required and no allowance can be made for pressure drop loss. A Zero Added Pressure Drop silencer is ideal for high velocity systems or systems that have little or no room for additional pressure drop. The IAC Quiet-Duct ZAPD series of silencers do not create any additional pressure drop in the system and have negligible Self-Noise Sound Power Levels. All Quiet-Duct Ultra™/ZAPD silencers have been rated with procedures certified in strict accordance with ASTM E477-99 in a NVLAP Accredited Acoustical Laboratory.

IAC Quiet-Duct Ultra™/ZAPD silencers have negligible Self Noise Sound Power levels. The Z6C has a 6" wide opening and two 7" baffles on each side, having a combined total width of 20", for effective acoustic attenuation.

Table I: Dynamic Insertion Loss (DIL) Ratings: Forward (+) / Reverse (-) Flow

Silencer Length (ft)	Octave Band	1	2	3	4	5	6	7	8
	Hz	63	125	250	500	1K	2K	4K	8K
	Face Velocity, fpm	Dynamic Insertion Loss, dB							
3	-2000	4	7	10	10	9	11	5	4
	-1000	4	7	11	10	9	12	5	4
	0	3	7	11	11	8	12	6	4
	1000	3	7	11	11	7	13	7	3
	2000	3	7	11	11	7	13	7	4
5	-2000	6	13	21	23	23	19	11	8
	-1000	6	13	21	24	23	20	12	9
	0	6	12	21	24	23	21	12	8
	1000	5	12	21	24	23	22	12	6
	2000	5	12	20	24	23	22	12	7
7	-2000	9	19	30	32	29	27	15	11
	-1000	8	18	30	32	30	28	16	12
	0	8	18	30	33	30	30	16	10
	1000	8	17	29	33	29	31	17	9
	2000	7	16	29	33	29	31	17	9
10	-2000	13	26	38	41	37	38	20	15
	-1000	12	25	38	41	38	39	21	16
	0	11	24	38	41	37	41	22	14
	1000	11	24	38	42	35	43	23	12
	2000	10	23	38	42	35	44	24	13

(+) Forward Flow / (-) Reverse Flow. Aero-acoustic performance data based on NVLAP accredited laboratory tests conducted in strict accordance with ASTM E477-99. Contact IAC if attenuation in excess of 50 dB is required.

Quiet-Duct Ultra™ / ZAPD Silencers

Type: Z6D

Forward & Reverse Flow Ratings

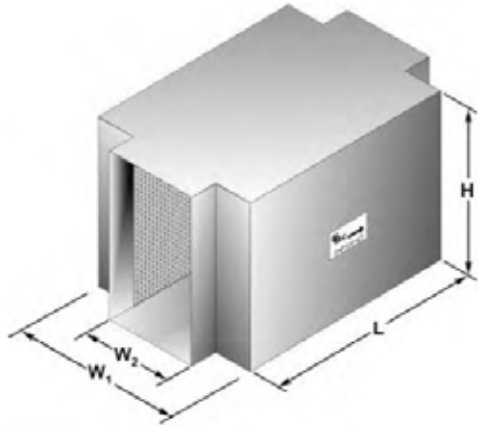

Designating Silencers

Model: 5Z6D 6x12

Type: Z6D **Length:** 5' **W₂:** 6" **Height:** 12"

All Z6D Silencers W₁ = 24"

This specific line of silencers has been designed for applications in which acoustics attenuation is required and no allowance can be made for pressure drop loss. A Zero Added Pressure Drop silencer is ideal for high velocity systems or systems that have little or no room for additional pressure drop. The IAC Quiet-Duct ZAPD series of silencers do not create any additional pressure drop in the system and have negligible Self-Noise Sound Power Levels. All Quiet-Duct Ultra™/ZAPD silencers have been rated with procedures certified in strict accordance with ASTM E477-99 in a NVLAP Accredited Acoustical Laboratory.

IAC Quiet-Duct Ultra™/ZAPD silencers have negligible Self Noise Sound Power levels. The Z6D has a 6" wide opening and two 18" baffles on each side, having a combined total width of 24", for effective acoustic attenuation.

Table I: Dynamic Insertion Loss (DIL) Ratings: Forward (+) / Reverse (-) Flow

Silencer Length (ft)	Octave Band	1	2	3	4	5	6	7	8
	Hz	63	125	250	500	1K	2K	4K	8K
	Face Velocity, fpm	Dynamic Insertion Loss, dB							
3	-2000	4	9	11	9	9	11	5	4
	-1000	4	8	11	9	9	12	6	5
	0	4	8	11	10	8	12	6	4
	1000	4	8	11	10	7	13	7	3
	2000	4	8	11	10	7	13	7	4
5	-2000	8	15	23	24	22	19	12	8
	-1000	7	15	22	24	23	20	12	9
	0	7	14	22	24	23	21	12	7
	1000	7	14	22	24	23	22	11	6
	2000	6	14	22	24	23	22	12	6
7	-2000	11	21	31	31	30	28	15	11
	-1000	10	21	31	31	31	28	16	12
	0	10	20	30	31	30	30	16	10
	1000	9	20	30	31	29	31	17	8
	2000	9	19	30	31	29	31	17	9
10	-2000	15	30	40	39	38	38	20	16
	-1000	14	29	40	40	39	39	21	16
	0	14	28	40	40	37	41	22	14
	1000	13	27	40	40	35	43	23	12
	2000	12	27	40	41	35	43	24	12

(+) Forward Flow / (-) Reverse Flow. Aero-acoustic performance data based on NVLAP accredited laboratory tests conducted in strict accordance with ASTM E477-99. Contact IAC if attenuation in excess of 50 dB is required.

Quiet-Duct Ultra™ / ZAPD Silencers

Type: Z6E

Forward & Reverse Flow Ratings

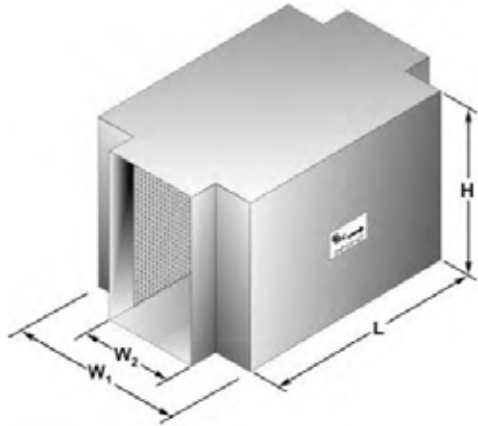

Designating Silencers

Model: 5Z6E 6x12

Type: Z6E **Length:** 5' **W₂:** 6" **Height:** 12"

All Z6E Silencers W₁ = 30"

This specific line of silencers has been designed for applications in which acoustics attenuation is required and no allowance can be made for pressure drop loss. A Zero Added Pressure Drop silencer is ideal for high velocity systems or systems that have little or no room for additional pressure drop. The IAC Quiet-Duct ZAPD series of silencers do not create any additional pressure drop in the system and have negligible Self-Noise Sound Power Levels. All Quiet-Duct Ultra™/ZAPD silencers have been rated with procedures certified in strict accordance with ASTM E477-99 in a NVLAP Accredited Acoustical Laboratory.

IAC Quiet-Duct Ultra™/ZAPD silencers have negligible Self Noise Sound Power levels. The Z6E has a 6" wide opening and two 24" baffles on each side, having a combined total width of 30", for effective acoustic attenuation.

Table I: Dynamic Insertion Loss (DIL) Ratings: Forward (+) / Reverse (-) Flow

Silencer Length (ft)	Octave Band	1	2	3	4	5	6	7	8
	Hz	63	125	250	500	1K	2K	4K	8K
	Face Velocity, fpm	Dynamic Insertion Loss, dB							
3	-2000	5	10	11	10	9	11	5	4
	-1000	5	10	11	10	9	12	6	5
	0	5	9	11	10	8	12	6	4
	1000	5	9	11	10	7	13	7	3
	2000	4	9	11	10	7	13	7	3
5	-2000	9	17	23	23	23	19	12	9
	-1000	9	16	23	23	23	20	12	9
	0	8	16	23	23	23	21	12	7
	1000	8	16	23	23	23	21	11	6
	2000	8	15	23	23	23	22	12	6
7	-2000	12	23	31	32	30	28	16	12
	-1000	12	23	31	32	31	29	16	12
	0	12	22	31	32	30	30	16	10
	1000	11	22	31	32	29	31	17	8
	2000	11	21	31	32	29	31	17	9
10	-2000	17	33	41	40	38	39	21	16
	-1000	17	32	41	40	39	40	21	17
	0	16	32	41	40	37	41	22	14
	1000	16	31	41	40	35	43	23	11
	2000	15	30	41	40	35	43	23	12

(+) Forward Flow / (-) Reverse Flow. Aero-acoustic performance data based on NVLAP accredited laboratory tests conducted in strict accordance with ASTM E477-99. Contact IAC if attenuation in excess of 50 dB is required.

Quiet-Duct Ultra™ / ZAPD Silencers

Type: Z9A

Forward & Reverse Flow Ratings

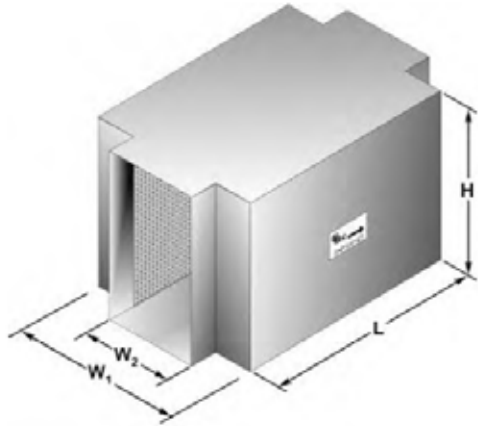

Designating Silencers

Model: 5Z9A 6 x 12

Type: Z9A **Length:** 5' **W₂:** 9" **Height:** 12"

All Z9A Silencers W₁ = 18"

This specific line of silencers has been designed for applications in which acoustics attenuation is required and no allowance can be made for pressure drop loss. A Zero Added Pressure Drop silencer is ideal for high velocity systems or systems that have little or no room for additional pressure drop. The IAC Quiet-Duct ZAPD series of silencers do not create any additional pressure drop in the system and have negligible Self-Noise Sound Power Levels. All Quiet-Duct Ultra™/ZAPD silencers have been rated with procedures certified in strict accordance with ASTM E477-99 in a NVLAP Accredited Acoustical Laboratory.

IAC Quiet-Duct Ultra™/ZAPD silencers have negligible Self Noise Sound Power levels. The Z9A has a 9" wide opening and two 4.5" baffles on each side, having a combined total width of 18", for effective acoustic attenuation.

Table I: Dynamic Insertion Loss (DIL) Ratings: Forward (+) / Reverse (-) Flow

Silencer Length (ft)	Octave Band	1	2	3	4	5	6	7	8
	Hz	63	125	250	500	1K	2K	4K	8K
	Face Velocity, fpm	Dynamic Insertion Loss, dB							
3	-2000	1	3	9	13	13	6	3	4
	-1000	1	3	8	13	14	7	4	4
	0	1	3	8	13	13	7	4	3
	1000	1	3	8	13	13	7	4	2
	2000	1	3	8	13	13	7	4	3
5	-2000	2	6	15	25	23	11	6	7
	-1000	2	6	15	25	23	11	7	7
	0	2	6	14	24	24	11	7	6
	1000	2	6	14	24	24	11	7	4
	2000	2	6	14	24	24	11	7	4
7	-2000	3	9	21	35	33	15	9	10
	-1000	3	8	21	35	34	16	11	10
	0	3	8	20	34	33	16	10	8
	1000	3	8	20	34	33	16	10	6
	2000	3	8	19	33	33	17	10	6
10	-2000	5	12	29	47	45	21	12	14
	-1000	5	12	29	46	46	22	14	14
	0	5	11	28	46	46	23	14	11
	1000	5	11	28	46	46	23	14	8
	2000	4	11	27	46	46	23	14	9

(+) Forward Flow / (-) Reverse Flow. Aero-acoustic performance data based on NVLAP accredited laboratory tests conducted in strict accordance with ASTM E477-99. Contact IAC if attenuation in excess of 50 dB is required.

Quiet-Duct Ultra™ / ZAPD Silencers

Type: Z9B

Forward & Reverse Flow Ratings

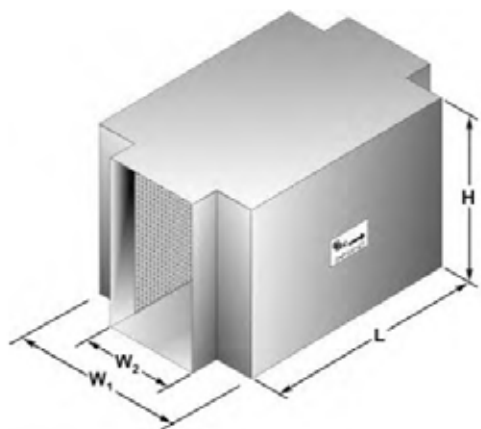

Designating Silencers

Model: 5Z9B 6x12

Type: Z9B **Length:** 5' **W₂:** 9" **Height:** 12"

All Z9B Silencers W₁ = 20"

This specific line of silencers has been designed for applications in which acoustics attenuation is required and no allowance can be made for pressure drop loss. A Zero Added Pressure Drop silencer is ideal for high velocity systems or systems that have little or no room for additional pressure drop. The IAC Quiet-Duct ZAPD series of silencers do not create any additional pressure drop in the system and have negligible Self-Noise Sound Power Levels. All Quiet-Duct Ultra™/ZAPD silencers have been rated with procedures certified in strict accordance with ASTM E477-99 in a NVLAP Accredited Acoustical Laboratory.

IAC Quiet-Duct Ultra™/ZAPD silencers have negligible Self Noise Sound Power levels. The Z9B has a 9" wide opening and two 5.5" baffles on each side, having a combined total width of 20", for effective acoustic attenuation.

Table I: Dynamic Insertion Loss (DIL) Ratings: Forward (+) / Reverse (-) Flow

Silencer Length (ft)	Octave Band	1	2	3	4	5	6	7	8
	Hz	63	125	250	500	1K	2K	4K	8K
	Face Velocity, fpm	Dynamic Insertion Loss, dB							
3	-2000	2	5	9	12	13	6	3	4
	-1000	2	5	9	12	14	7	4	4
	0	2	4	9	12	14	7	4	3
	1000	2	4	9	12	13	7	4	2
	2000	2	4	9	12	13	7	4	3
5	-2000	3	8	17	24	23	11	6	7
	-1000	3	8	16	24	23	11	7	7
	0	3	8	16	24	23	11	7	6
	1000	3	7	16	23	24	11	7	4
	2000	3	7	16	23	24	11	7	4
7	-2000	5	12	24	34	33	16	9	10
	-1000	5	11	23	33	34	16	11	10
	0	4	11	23	33	33	16	10	8
	1000	4	10	23	33	33	16	10	6
	2000	4	10	22	33	33	17	10	6
10	-2000	7	16	32	44	45	22	12	14
	-1000	7	16	32	44	47	22	14	14
	0	7	15	31	44	46	23	14	11
	1000	6	15	31	44	46	23	14	8
	2000	6	14	31	44	46	23	14	9

(+) Forward Flow / (-) Reverse Flow. Aero-acoustic performance data based on NVLAP accredited laboratory tests conducted in strict accordance with ASTM E477-99. Contact IAC if attenuation in excess of 50 dB is required.

Quiet-Duct Ultra™ / ZAPD Silencers

Type: Z9C

Forward & Reverse Flow Ratings

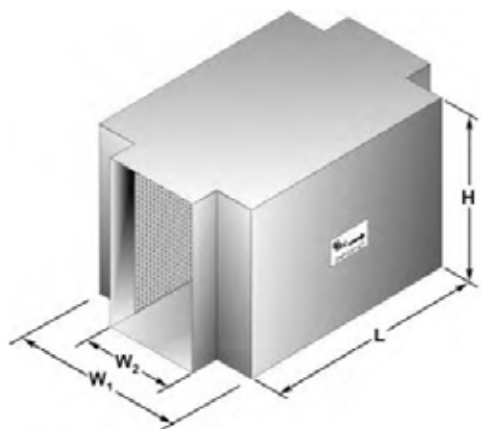

Designating Silencers

Model: 5Z9C 6 x 12

Type: Z9C **Length:** 5' **W₂:** 9" **Height:** 12"

All Z9C Silencers W₁ = 22 ½"

This specific line of silencers has been designed for applications in which acoustics attenuation is required and no allowance can be made for pressure drop loss. A Zero Added Pressure Drop silencer is ideal for high velocity systems or systems that have little or no room for additional pressure drop. The IAC Quiet-Duct ZAPD series of silencers do not create any additional pressure drop in the system and have negligible Self-Noise Sound Power Levels. All Quiet-Duct Ultra™/ZAPD silencers have been rated with procedures certified in strict accordance with ASTM E477-99 in a NVLAP Accredited Acoustical Laboratory.

IAC Quiet-Duct Ultra™/ZAPD silencers have negligible Self Noise Sound Power levels. The Z9C has a 9" wide opening and two 6.75" baffles on each side, having a combined total width of 22.5", for effective acoustic attenuation.

Table I: Dynamic Insertion Loss (DIL) Ratings: Forward (+) / Reverse (-) Flow

Silencer Length (ft)	Octave Band	1	2	3	4	5	6	7	8
	Hz	63	125	250	500	1K	2K	4K	8K
	Face Velocity, fpm	Dynamic Insertion Loss, dB							
3	-2000	3	6	10	11	13	6	3	4
	-1000	3	6	10	11	14	7	4	4
	0	3	6	10	12	14	7	4	3
	1000	2	5	10	12	13	7	4	2
	2000	2	5	10	12	13	7	4	3
5	-2000	5	10	18	23	23	11	7	7
	-1000	4	10	18	23	23	11	7	7
	0	4	10	18	23	24	11	7	6
	1000	4	9	18	23	24	11	7	4
	2000	4	9	18	23	24	11	7	4
7	-2000	7	15	26	32	33	16	9	10
	-1000	6	14	26	32	34	16	11	10
	0	6	14	25	32	34	16	10	8
	1000	6	13	25	32	33	16	10	6
	2000	5	13	25	32	33	17	10	6
10	-2000	9	20	35	42	45	22	12	14
	-1000	9	20	34	42	47	22	14	14
	0	8	19	34	42	46	23	14	11
	1000	8	18	34	42	46	23	14	8
	2000	8	18	34	42	46	23	14	9

(+) Forward Flow / (-) Reverse Flow. Aero-acoustic performance data based on NVLAP accredited laboratory tests conducted in strict accordance with ASTM E477-99. Contact IAC if attenuation in excess of 50 dB is required.

Quiet-Duct Ultra™ / ZAPD Silencers

Type: Z9D

Forward & Reverse Flow Ratings

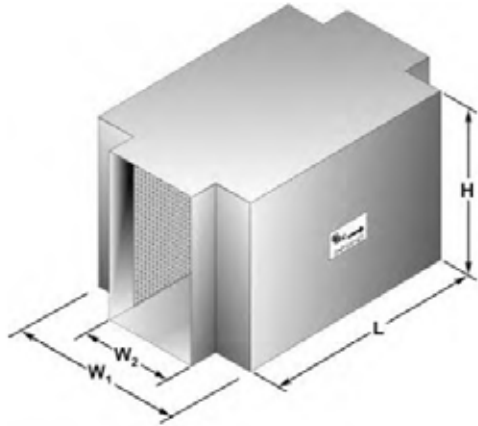

Designating Silencers

Model: 5Z9D 6x12

Type: Z9D **Length:** 5' **W₂:** 9" **Height:** 12"

All Z9D Silencers W₁ = 30"

This specific line of silencers has been designed for applications in which acoustics attenuation is required and no allowance can be made for pressure drop loss. A Zero Added Pressure Drop silencer is ideal for high velocity systems or systems that have little or no room for additional pressure drop. The IAC Quiet-Duct ZAPD series of silencers do not create any additional pressure drop in the system and have negligible Self-Noise Sound Power Levels. All Quiet-Duct Ultra™/ZAPD silencers have been rated with procedures certified in strict accordance with ASTM E477-99 in a NVLAP Accredited Acoustical Laboratory.

IAC Quiet-Duct Ultra™/ZAPD silencers have negligible Self Noise Sound Power levels. The Z9D has a 9" wide opening and two 10.5" baffles on each side, having a combined total width of 30", for effective acoustic attenuation.

Table I: Dynamic Insertion Loss (DIL) Ratings: Forward (+) / Reverse (-) Flow

Silencer Length (ft)	Octave Band	1	2	3	4	5	6	7	8
	Hz	63	125	250	500	1K	2K	4K	8K
	Face Velocity, fpm	Dynamic Insertion Loss, dB							
3	-2000	4	8	10	10	13	7	4	4
	-1000	4	8	10	10	14	7	4	4
	0	4	8	10	10	14	7	4	3
	1000	4	7	10	10	13	7	4	2
	2000	3	7	10	10	13	7	4	2
5	-2000	7	14	21	22	23	11	7	7
	-1000	7	14	20	22	23	11	7	7
	0	7	13	20	22	24	11	7	6
	1000	6	13	20	22	24	11	7	4
	2000	6	13	20	22	24	11	7	4
7	-2000	10	19	28	30	33	16	10	10
	-1000	10	19	28	30	34	16	11	10
	0	9	18	28	30	34	16	10	8
	1000	9	18	28	30	33	16	10	6
	2000	8	17	27	30	33	17	10	6
10	-2000	14	28	37	39	45	22	14	14
	-1000	13	27	37	39	48	22	14	14
	0	13	26	37	39	47	22	14	11
	1000	12	25	37	39	46	23	14	8
	2000	12	25	37	39	46	23	14	8

(+) Forward Flow / (-) Reverse Flow. Aero-acoustic performance data based on NVLAP accredited laboratory tests conducted in strict accordance with ASTM E477-99. Contact IAC if attenuation in excess of 50 dB is required.

Quiet-Duct Ultra™ / ZAPD Silencers

Type: Z9E

Forward & Reverse Flow Ratings

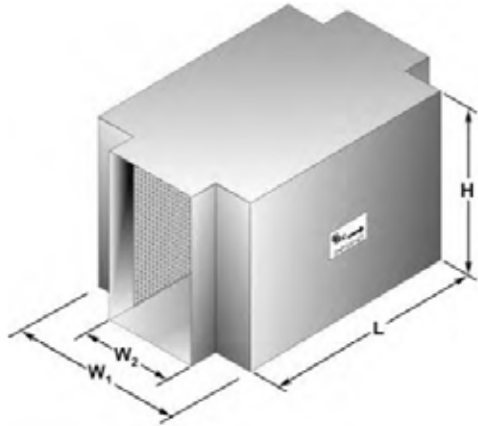

Designating Silencers

Model: 5Z9E 6 x 12

Type: Z9E **Length:** 5' **W₂:** 9" **Height:** 12"

All Z9E Silencers W₁ = 36"

This specific line of silencers has been designed for applications in which acoustics attenuation is required and no allowance can be made for pressure drop loss. A Zero Added Pressure Drop silencer is ideal for high velocity systems or systems that have little or no room for additional pressure drop. The IAC Quiet-Duct ZAPD series of silencers do not create any additional pressure drop in the system and have negligible Self-Noise Sound Power Levels. All Quiet-Duct Ultra™/ZAPD silencers have been rated with procedures certified in strict accordance with ASTM E477-99 in a NVLAP Accredited Acoustical Laboratory.

IAC Quiet-Duct Ultra™/ZAPD silencers have negligible Self Noise Sound Power levels. The Z9E has a 9" wide opening and two 13.5" baffles on each side, having a combined total width of 36", for effective acoustic attenuation.

Table I: Dynamic Insertion Loss (DIL) Ratings: Forward (+) / Reverse (-) Flow

Silencer Length (ft)	Octave Band	1	2	3	4	5	6	7	8
	Hz	63	125	250	500	1K	2K	4K	8K
	Face Velocity, fpm	Dynamic Insertion Loss, dB							
3	-2000	5	9	10	10	14	7	4	4
	-1000	5	8	10	10	15	7	4	4
	0	4	8	10	10	14	7	4	3
	1000	4	8	10	10	13	7	4	2
	2000	4	8	10	10	13	7	4	2
5	-2000	8	15	20	21	23	11	7	7
	-1000	8	15	20	21	24	11	7	7
	0	8	15	20	20	24	11	7	6
	1000	7	14	20	20	24	11	7	4
	2000	7	14	20	20	24	11	7	4
7	-2000	11	21	29	30	34	16	11	10
	-1000	11	21	29	30	34	16	11	10
	0	11	21	29	30	34	16	10	8
	1000	10	20	29	30	33	16	10	6
	2000	10	20	28	30	33	16	10	6
10	-2000	16	30	37	37	47	22	14	14
	-1000	16	29	37	37	48	22	14	14
	0	15	29	36	37	47	22	14	11
	1000	15	28	36	37	46	22	14	8
	2000	14	27	36	37	46	23	14	8

(+) Forward Flow / (-) Reverse Flow. Aero-acoustic performance data based on NVLAP accredited laboratory tests conducted in strict accordance with ASTM E477-99. Contact IAC if attenuation in excess of 50 dB is required.

Quiet-Duct Ultra™ / ZAPD Silencers

Type: Z12A

Forward & Reverse Flow Ratings

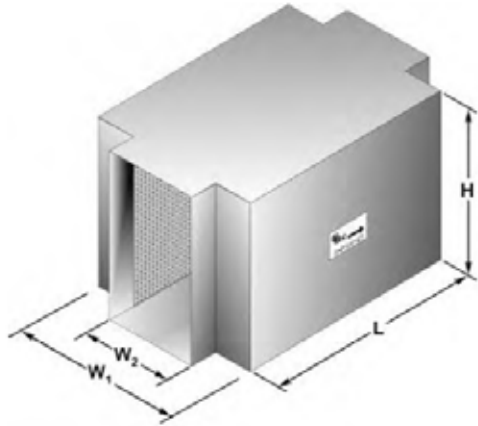

Designating Silencers

Model: 5Z12A 6x12

Type: Z12A **Length:** 5' **W₂:** 12" **Height:** 12"

All Z12A Silencers W₁ = 24"

This specific line of silencers has been designed for applications in which acoustics attenuation is required and no allowance can be made for pressure drop loss. A Zero Added Pressure Drop silencer is ideal for high velocity systems or systems that have little or no room for additional pressure drop. The IAC Quiet-Duct ZAPD series of silencers do not create any additional pressure drop in the system and have negligible Self-Noise Sound Power Levels. All Quiet-Duct Ultra™/ZAPD silencers have been rated with procedures certified in strict accordance with ASTM E477-99 in a NVLAP Accredited Acoustical Laboratory.

IAC Quiet-Duct Ultra™/ZAPD silencers have negligible Self Noise Sound Power levels. The Z12A has a 12" wide opening and two 6" baffles on each side, having a combined total width of 24", for effective acoustic attenuation.

Table I: Dynamic Insertion Loss (DIL) Ratings: Forward (+) / Reverse (-) Flow

Silencer Length (ft)	Octave Band	1	2	3	4	5	6	7	8
	Hz	63	125	250	500	1K	2K	4K	8K
	Face Velocity, fpm	Dynamic Insertion Loss, dB							
3	-2000	2	4	9	13	11	5	3	4
	-1000	2	4	9	13	11	5	3	4
	0	2	4	9	13	10	4	3	3
	1000	2	4	9	12	9	4	3	2
	2000	1	4	9	12	9	4	3	3
5	-2000	3	7	16	22	17	9	5	7
	-1000	3	7	16	22	18	9	6	7
	0	2	7	15	22	18	8	6	6
	1000	2	7	15	22	19	8	5	5
	2000	2	6	15	21	19	8	5	6
7	-2000	4	10	22	32	25	13	7	10
	-1000	4	10	22	32	26	12	8	10
	0	4	10	21	31	25	12	8	8
	1000	3	9	21	31	25	11	7	7
	2000	3	9	21	30	25	11	7	7
10	-2000	5	14	31	44	36	17	10	13
	-1000	5	14	31	43	36	17	12	13
	0	5	14	30	43	35	16	11	11
	1000	5	13	30	42	34	14	10	10
	2000	5	13	29	42	35	15	10	10

(+) Forward Flow / (-) Reverse Flow. Aero-acoustic performance data based on NVLAP accredited laboratory tests conducted in strict accordance with ASTM E477-99. Contact IAC if attenuation in excess of 50 dB is required.

Quiet-Duct Ultra™ / ZAPD Silencers

Type: Z12B

Forward & Reverse Flow Ratings

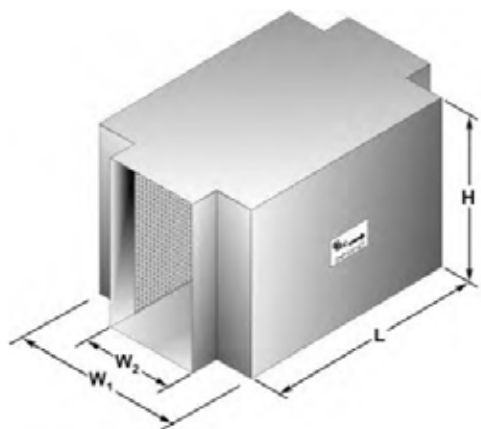

Designating Silencers

Model: 5Z12B 6 x 12

Type: Z12B **Length:** 5' **W₂:** 12" **Height:** 12"

All Z12B Silencers W₁ = 30"

This specific line of silencers has been designed for applications in which acoustics attenuation is required and no allowance can be made for pressure drop loss. A Zero Added Pressure Drop silencer is ideal for high velocity systems or systems that have little or no room for additional pressure drop. The IAC Quiet-Duct ZAPD series of silencers do not create any additional pressure drop in the system and have negligible Self-Noise Sound Power Levels. All Quiet-Duct Ultra™/ZAPD silencers have been rated with procedures certified in strict accordance with ASTM E477-99 in a NVLAP Accredited Acoustical Laboratory.

IAC Quiet-Duct Ultra™/ZAPD silencers have negligible Self Noise Sound Power levels. The Z12B has a 12" wide opening and two 9" baffles on each side, having a combined total width of 30", for effective acoustic attenuation.

Table I: Dynamic Insertion Loss (DIL) Ratings: Forward (+) / Reverse (-) Flow

Silencer Length (ft)	Octave Band	1	2	3	4	5	6	7	8
	Hz	63	125	250	500	1K	2K	4K	8K
	Face Velocity, fpm	Dynamic Insertion Loss, dB							
3	-2000	3	6	10	11	11	5	3	4
	-1000	3	6	9	11	11	5	3	4
	0	3	6	9	11	10	4	3	3
	1000	3	6	9	11	9	4	3	2
	2000	2	6	9	11	9	4	3	3
5	-2000	5	11	18	20	17	9	5	7
	-1000	5	11	18	20	18	9	6	7
	0	5	10	18	20	18	8	6	6
	1000	4	10	17	20	19	8	5	5
	2000	4	10	17	20	19	8	5	6
7	-2000	7	15	25	28	25	13	7	10
	-1000	7	15	25	28	26	12	8	10
	0	7	14	24	28	25	12	8	8
	1000	6	14	24	28	25	11	7	7
	2000	6	14	24	28	25	11	7	7
10	-2000	10	22	34	38	35	17	10	13
	-1000	10	21	34	38	36	17	12	13
	0	9	20	33	38	35	16	11	11
	1000	9	20	33	38	33	14	10	9
	2000	8	19	33	38	34	15	10	10

(+) Forward Flow / (-) Reverse Flow. Aero-acoustic performance data based on NVLAP accredited laboratory tests conducted in strict accordance with ASTM E477-99. Contact IAC if attenuation in excess of 50 dB is required.

Quiet-Duct Ultra™ / ZAPD Silencers

Type: Z12C

Forward & Reverse Flow Ratings

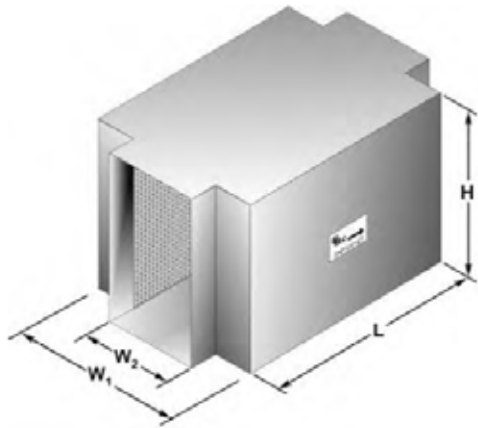

Designating Silencers

Model: 5Z12C 6x12

Type: Z12C **Length:** 5' **W₂:** 12" **Height:** 12"

All Z12C Silencers W₁ = 40"

This specific line of silencers has been designed for applications in which acoustics attenuation is required and no allowance can be made for pressure drop loss. A Zero Added Pressure Drop silencer is ideal for high velocity systems or systems that have little or no room for additional pressure drop. The IAC Quiet-Duct ZAPD series of silencers do not create any additional pressure drop in the system and have negligible Self-Noise Sound Power Levels. All Quiet-Duct Ultra™/ZAPD silencers have been rated with procedures certified in strict accordance with ASTM E477-99 in a NVLAP Accredited Acoustical Laboratory.

IAC Quiet-Duct Ultra™/ZAPD silencers have negligible Self Noise Sound Power levels. The Z12C has a 12" wide opening and two 14" baffles on each side, having a combined total width of 40", for effective acoustic attenuation.

Table I: Dynamic Insertion Loss (DIL) Ratings: Forward (+) / Reverse (-) Flow

Silencer Length (ft)	Octave Band	1	2	3	4	5	6	7	8
	Hz	63	125	250	500	1K	2K	4K	8K
	Face Velocity, fpm	Dynamic Insertion Loss, dB							
3	-2000	4	8	10	10	10	5	3	4
	-1000	4	8	9	10	11	5	4	3
	0	4	7	9	10	10	4	3	3
	1000	4	7	9	9	9	4	3	2
	2000	4	7	9	9	9	4	3	3
5	-2000	7	14	18	18	18	9	6	7
	-1000	7	14	18	18	18	9	6	7
	0	7	13	18	18	18	8	6	6
	1000	7	13	18	18	19	8	5	5
	2000	6	13	18	18	19	8	5	6
7	-2000	10	20	27	27	25	13	8	10
	-1000	10	19	26	27	26	12	9	10
	0	10	19	26	27	25	11	8	8
	1000	9	18	26	27	24	11	7	7
	2000	9	18	26	26	25	11	7	7
10	-2000	15	27	34	35	35	17	12	13
	-1000	14	26	34	34	36	16	12	13
	0	14	26	34	34	34	15	11	11
	1000	13	25	34	34	33	14	10	9
	2000	13	25	33	34	34	14	10	10

(+) Forward Flow / (-) Reverse Flow. Aero-acoustic performance data based on NVLAP accredited laboratory tests conducted in strict accordance with ASTM E477-99. Contact IAC if attenuation in excess of 50 dB is required.

Quiet-Duct Ultra™ / ZAPD Silencers

Type: Z12D

Forward & Reverse Flow Ratings

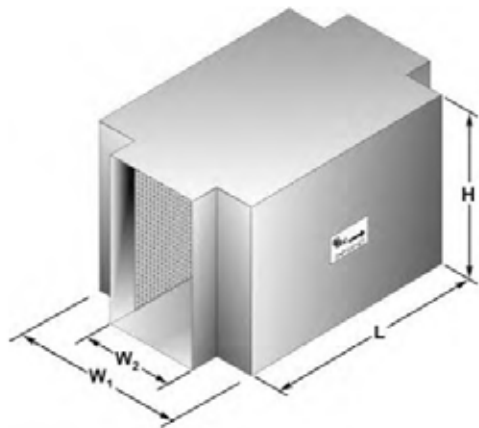

Designating Silencers

Model: 5Z12D 6x12

Type: Z12D **Length:** 5' **W₂:** 12" **Height:** 12"

All Z12D Silencers W₁ = 48"

This specific line of silencers has been designed for applications in which acoustics attenuation is required and no allowance can be made for pressure drop loss. A Zero Added Pressure Drop silencer is ideal for high velocity systems or systems that have little or no room for additional pressure drop. The IAC Quiet-Duct ZAPD series of silencers do not create any additional pressure drop in the system and have negligible Self-Noise Sound Power Levels. All Quiet-Duct Ultra™/ZAPD silencers have been rated with procedures certified in strict accordance with ASTM E477-99 in a NVLAP Accredited Acoustical Laboratory.

IAC Quiet-Duct Ultra™/ZAPD silencers have negligible Self Noise Sound Power levels. The Z12D has a 12" wide opening and two 18" baffles on each side, having a combined total width of 48", for effective acoustic attenuation.

Table I: Dynamic Insertion Loss (DIL) Ratings: Forward (+) / Reverse (-) Flow

Silencer Length (ft)	Octave Band	1	2	3	4	5	6	7	8
	Hz	63	125	250	500	1K	2K	4K	8K
	Face Velocity, fpm	Dynamic Insertion Loss, dB							
3	-2000	5	8	10	10	11	5	3	4
	-1000	5	8	10	10	10	5	4	3
	0	5	8	10	10	9	4	3	3
	1000	4	8	10	10	9	4	3	2
	2000	4	8	10	10	9	4	3	2
5	-2000	8	15	18	18	18	9	6	7
	-1000	8	15	18	17	18	9	6	7
	0	8	14	18	17	18	8	6	6
	1000	8	14	18	17	19	8	5	5
	2000	7	14	17	17	19	8	5	5
7	-2000	11	21	26	25	26	12	8	10
	-1000	11	21	26	25	26	12	9	10
	0	11	21	25	25	25	11	8	8
	1000	11	20	25	25	24	11	7	7
	2000	10	20	25	25	25	11	7	7
10	-2000	16	29	35	34	36	17	12	13
	-1000	16	29	35	34	35	16	12	13
	0	15	28	34	34	34	15	11	11
	1000	15	28	34	33	33	14	10	9
	2000	15	27	34	33	34	14	10	10

(+) Forward Flow / (-) Reverse Flow. Aero-acoustic performance data based on NVLAP accredited laboratory tests conducted in strict accordance with ASTM E477-99. Contact IAC if attenuation in excess of 50 dB is required.

Quiet-Duct Commercial Series Silencers

Section 15000 Specifications

1.01 General

- A. Furnish and install "Quiet-Duct" (rectangular) silencers of the types and sizes shown on the plans and/or listed in the schedule. Silencers shall be the product of IAC Acoustics. Any specification change must be submitted in writing and approved by the Architect/Engineer, in writing, at least 10 days prior to the bid due-date.

2.01 Materials

- A. Outer casings of rectangular silencers shall be made of 22 gauge type #G-90 lock-former-quality galvanized steel.
- B. Interior partitions for rectangular silencers shall be not less than 26 gauge type #G-90 galvanized lock-former-quality perforated steel.
- C. Filler material shall be inorganic glass fiber of a proper density to obtain the specified acoustic performance and be packed under not less than 5% compression to eliminate voids due to vibration and settling. Material shall be inert, vermin- and moisture-proof.
- D. Combustion ratings for the silencer acoustic fill shall be not greater than the following when tested to ASTM E 84, NFPA Standard 255, or UL No. 723:

Flamespread Classification	20
Smoke Development Rating.....	20

3.01 Construction

- A. Units shall be constructed in accordance with the ASHRAE Guide recommendations for high pressure duct work. Seams shall be lock formed and mastic filled. Rectangular casing seams shall be in the corners of the silencer shell to provide maximum unit strength and rigidity. Interior partitions shall be fabricated from single-piece, margin-perforated sheets and shall have die-formed entrance and exit shapes so as to provide the maximum aerodynamic efficiency and minimum self-noise characteristics in the sound attenuator. Blunt noses or squared off partitions will not be accepted.
- B. Attachment of the interior partitions to the casing shall be by means of an interlocking track assembly. Tracks shall be solid galvanized steel and shall be welded to the outer casing. Attachment of the interior partitions to the tracks shall be such that a minimum of 4 thicknesses of metal exist at this location. The track assembly shall stiffen the exterior casing, provide a reinforced attachment detail for the interior partitions, and shall maintain a uniform airspace width along the length of the silencer for consistent aerodynamic and acoustic performance. Interior partitions shall be additionally secured to the outer casing with welded nose clips at both ends of the sound attenuator.

- C. Sound attenuating units shall not fail structurally when subjected to a differential air pressure of 8 inches water gauge from inside to outside the casing. Airtight construction shall be provided by use of a duct sealing compound on the job-site material and labor furnished by the contractor.

4.01 Acoustic Performance

- A. All silencer ratings shall be determined in a duct-to-reverberant room test facility which provides for airflow in both directions through the test silencer in accordance with ASTM Specification E477-99. The test facility shall be NVLAP accredited for the ASTM E477-99 test standard. Data from a non-accredited laboratory will not be acceptable. The test set-up and procedure shall be such that all effects due to end reflection, directivity, flanking transmission, standing waves and test chamber sound absorption are eliminated.

Acoustic ratings shall include Dynamic Insertion Loss (DIL) and Self-Noise (SN) Power Levels both for FORWARD FLOW (air and noise in same direction) and REVERSE FLOW (air and noise in opposite directions) with airflow of at least 2000 fpm entering face velocity. Data for rectangular and tubular type silencers shall be presented for tests conducted using silencers no smaller than the following cross-sections:

Rectangular, inch: 24 x 24, 24 x 30, or 24 x 36
Tubular, inch: 12, 24, 36 and 48

5.01 Aerodynamic Performance

- A. Static pressure loss of silencers shall not exceed those listed in the silencer schedule as the airflow indicates. Airflow measurements shall be made in accordance with ASTM specification E477-99 and applicable portions of ASME, AMCA, and ADC airflow test codes. Tests shall be reported on the identical units for which acoustic data is presented.

6.01 Certification

- A. With submittals, the manufacturer shall supply certified test data on Dynamic Insertion Loss, Self-Noise Power Levels, and Aerodynamic Performance for Reverse and Forward Flow test conditions. Test data shall be for a standard product. All rating tests shall be conducted in the same facility, shall utilize the same silencer, and shall be open to inspection upon request from the Architect/Engineer.

7.01 Duct Transitions

- A. When transitions are required to adapt silencer dimensions to connecting duct work they shall be furnished by the installing contractor.

Quiet-Duct Commercial Series Silencers

Type: LFS

Forward & Reverse Flow Ratings



The IAC Type LFS Quiet-Duct Silencers provide superior low frequency attenuation. When low frequencies are controlling, a Type LFS selection often results in a shorter silencer length than the equivalent Type S Quiet-Duct Silencer.

All LFS Silencers have been rated and certified with procedures certified in accordance with applicable portions of ASTM E4777. All Dynamic Insertion Loss and Self-Noise Acoustic Performance data were obtained in a NVLAP accredited Aero-Acoustic Laboratory using the duct-to-room reverberant test facility with air flowing through the silencers.

Type LFS Silencers are advantageous where low frequency DIL requirements are high in HVAC systems. In some systems, high frequency attenuation may be provided by the system components or may not be needed.

Designating Silencers

Model: 5LFS 24 x 18

Type: LFS **Length:** 5' **W:** 24" **Height:** 18"

Table I: Dynamic Insertion Loss (DIL) Ratings: Forward (+) / Reverse (-) Flow

IAC Model	Octave Band	1	2	3	4	5	6	7	8
	Hz	63	125	250	500	1K	2K	4K	8K
	Face Velocity, fpm	Dynamic Insertion Loss, dB							
3LFS	-2000	8	14	25	29	27	20	16	12
	-1000	7	13	23	28	26	20	16	14
	0	8	13	23	28	27	21	17	14
	1000	9	12	22	28	27	21	18	14
	2000	7	11	21	25	25	21	17	14
5LFS	-2000	13	23	36	42	42	28	19	14
	-1000	13	21	35	41	41	28	21	15
	0	13	20	33	39	41	28	22	16
	1000	12	19	31	36	40	27	22	16
	2000	10	17	28	33	37	29	20	16
7LFS	-2000	14	25	40	50	51	35	22	16
	-1000	14	24	42	49	49	35	24	17
	0	13	24	40	47	47	34	25	17
	1000	12	23	37	44	45	33	25	17
	2000	10	22	37	44	45	34	24	17
10LFS	-2000	19	30	46	52	53	43	25	17
	-1000	18	32	50	52	53	45	29	19
	0	18	30	49	52	53	46	32	21
	1000	17	28	47	52	53	47	35	23
	2000	16	25	46	53	53	48	36	24

(+) Forward Flow / (-) Reverse Flow. Aero-acoustic performance data based on NVLAP accredited laboratory tests conducted in strict accordance with ASTM E477-99. Contact IAC if attenuation in excess of 50 dB is required.

Table II: Weights & Measures

Nominal Length	W/In H/In	6	6	6	6	6	6	12	12	12	12	12	12	24	24	24
3'	Wt/lb.	18	21	25	29	31	35	35	42	50	57	61	70	54	64	74
5'		29	35	42	47	52	59	58	70	83	94	104	117	89	104	121
7'		41	49	59	67	75	83	82	98	118	134	150	166	125	146	175
10'		59	70	84	95	N/A	N/A	117	140	167	190	N/A	N/A	178	209	250

Nominal Length	W/In H/In	24	24	24	36	36	36	36	36	36	48	48	48	48	48	48
3'	Wt/lb.	82	92	102	89	106	124	139	153	172	108	128	148	164	184	204
5'		136	152	157	147	174	204	230	256	274	178	208	242	272	304	314
7'		196	218	240	207	244	293	330	N/A	N/A	N/A	N/A	N/A	N/A	N/A	N/A
10'		280	N/A	N/A	295	349	417	470	N/A	N/A	N/A	N/A	N/A	N/A	N/A	N/A

Table III: Aerodynamic Performance

IAC Model	L/Ft	Static Pressure Drop, i.w.g.															
LFS	3'	0.04	0.05	0.07	0.09	0.11	0.14	0.17	0.20	0.24	0.28	0.32	0.36	0.41	0.46	0.51	0.57
	5'	0.04	0.06	0.08	0.10	0.13	0.16	0.19	0.22	0.26	0.31	0.35	0.40	0.45	0.51	0.56	0.62
	7'	0.04	0.06	0.08	0.10	0.13	0.16	0.20	0.23	0.28	0.32	0.37	0.42	0.47	0.53	0.59	0.65
	10'	0.04	0.06	0.09	0.11	0.14	0.18	0.21	0.26	0.30	0.35	0.40	0.45	0.51	0.57	0.64	0.71
Silencer Face Velocity, fpm		250	300	350	400	450	500	550	600	650	700	750	800	850	900	950	1000

Table IV: Self-Noise Power Levels, dB re: 10-12 Watts

IAC Model	Octave Band	1	2	3	4	5	6	7	8
	Hz	63	125	250	500	1K	2K	4K	8K
	Silencer Face Velocity, fpm								
LFS (all sizes)	-2000	58	54	58	61	62	62	65	63
	-1500	51	49	53	56	56	59	60	53
	-1000	45	42	45	43	45	49	44	37
	1000	46	42	45	43	45	49	44	37
	1500	56	54	57	56	52	56	57	51
	2000	68	64	65	66	61	61	64	61

(+) Forward Flow / (-) Reverse Flow. Aero-acoustic performance data based on NVLAP accredited laboratory tests conducted in strict accordance with ASTM E477-99.

TAKE NOTE!

- Silencer Face Area is the cross-sectional area at the silencer entrance
- Face Velocity is the CFM of airflow divided by the Face Area (in sq. ft.)
- Pressure Drop for any velocity can be calculated from this equation:
 $PD = (Actual\ FV/Catalog\ FV)^2 \times (Catalog\ PD)$
- Self Noise values shown are for a four-square-foot face area silencer
- For each doubling of the face area add 3 dB to the self-noise values listed
- For each halving of the face area subtract 3 dB from the self-noise values listed
- Weights and measures are listed for limited number of available sizes

Quiet-Duct Commercial Series Silencers

Type: LFM

Forward & Reverse Flow Ratings

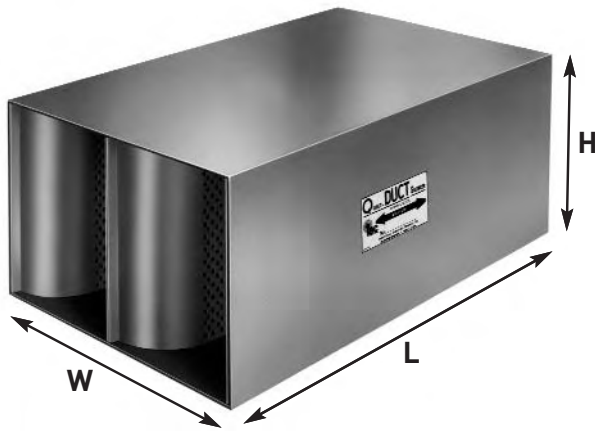

The IAC Type LFM Quiet-Duct Silencers provide improved low frequency attenuation particularly in the third octave band. When third band performance is critical, a Type LFM Quiet-Duct selection often results in a shorter silencer length than other equivalent silencer models.

Type LFM Quiet-Duct Silencers have been rated with procedures certified in accordance with applicable portions of ASTM E477. All Dynamic Insertion Loss and Self-Noise Acoustic Performance Data were obtained in a NVLAP accredited Aero-Acoustic Laboratory using the duct-to-room reverberant test facility **with air flowing through the silencers.**

Type LFM Silencers are advantageous where low frequency, particularly third octave band, DIL requirements are high in HVAC systems. In some applications high frequency attenuation may be provided by the system components or may not be needed.

Designating Silencers

Model: 5LFM 24 x 18

Type: LFM **Length:** 5' **W:** 24" **Height:** 18"

Table I: Dynamic Insertion Loss (DIL) Ratings: Forward (+) / Reverse (-) Flow

IAC Model	Octave Band	1	2	3	4	5	6	7	8
	Hz	63	125	250	500	1K	2K	4K	8K
	Face Velocity, fpm	Dynamic Insertion Loss, dB							
3LFM	-2000	6	9	17	22	19	14	12	10
	-1000	6	8	16	21	18	13	12	11
	0	5	8	16	21	18	13	12	11
	1000	4	7	15	20	17	13	11	10
	2000	4	7	14	19	17	12	11	10
5LFM	-2000	9	16	26	32	29	17	13	13
	-1000	9	15	26	31	30	17	15	13
	0	9	14	25	30	29	17	15	13
	1000	8	13	23	29	28	17	14	13
	2000	7	12	22	28	28	17	14	12
7LFM	-2000	12	18	32	44	39	21	16	14
	-1000	12	18	32	43	39	21	18	15
	0	12	17	31	42	39	22	18	15
	1000	12	16	30	41	38	22	17	14
	2000	11	15	28	39	38	23	17	15
10LFM	-2000	16	24	41	51	51	26	20	16
	-1000	16	24	42	51	50	27	22	17
	0	16	23	41	51	50	28	22	17
	1000	15	22	39	50	50	28	21	16
	2000	14	20	38	50	50	28	22	17

(+) Forward Flow / (-) Reverse Flow. Aero-acoustic performance data based on NVLAP accredited laboratory tests conducted in strict accordance with ASTM E477-99. Contact IAC if attenuation in excess of 50 dB is required.

Table II: Weights & Measures

Nominal Length	W/In H/In	6	6	6	6	6	6	12	12	12	12	12	12	24	24	24
3'	Wt/lb.	18	21	25	29	31	35	35	42	50	57	61	70	54	64	74
5'		29	35	42	47	52	59	58	70	83	94	104	117	89	104	121
7'		41	49	59	67	75	83	82	98	118	134	150	166	125	146	175
10'		59	70	84	95	N/A	N/A	117	140	167	190	N/A	N/A	178	209	250

Nominal Length	W/In H/In	24	24	24	36	36	36	36	36	36	48	48	48	48	48	48
3'	Wt/lb.	82	92	102	89	106	124	139	153	172	108	128	148	164	184	204
5'		136	152	157	147	174	204	230	256	274	178	208	242	272	304	314
7'		196	218	240	207	244	293	330	N/A	N/A	N/A	N/A	N/A	N/A	N/A	N/A
10'		280	N/A	N/A	295	349	417	470	N/A	N/A	N/A	N/A	N/A	N/A	N/A	N/A

Table III: Aerodynamic Performance

IAC Model	L/Ft	Static Pressure Drop, i.w.g.															
LFM	3'	0.05	0.07	0.09	0.12	0.15	0.19	0.23	0.27	0.32	0.37	0.42	0.48	0.55	0.61	0.68	0.76
	5'	0.05	0.07	0.10	0.13	0.16	0.20	0.24	0.29	0.34	0.39	0.45	0.51	0.57	0.64	0.72	0.79
	7'	0.05	0.07	0.10	0.13	0.17	0.21	0.25	0.30	0.35	0.41	0.47	0.53	0.60	0.67	0.75	0.83
	10'	0.06	0.08	0.12	0.15	0.19	0.24	0.29	0.34	0.40	0.46	0.53	0.60	0.68	0.76	0.85	0.94
Silencer Face Velocity, fpm		500	600	700	800	900	1000	1100	1200	1300	1400	1500	1600	1700	1800	1900	2000

Table IV: Self-Noise Power Levels, dB re: 10-12 Watts

IAC Model	Octave Band	1	2	3	4	5	6	7	8
	Hz	63	125	250	500	1K	2K	4K	8K
	Silencer Face Velocity, fpm								
LFM (all sizes)	-3000	64	62	64	66	65	64	66	62
	-2000	53	50	54	56	56	59	58	51
	-1000	42	40	43	45	47	46	37	27
	1000	47	34	36	35	40	37	27	20
	2000	54	52	58	56	51	56	55	50
	3000	68	64	64	63	61	63	66	63

(+) Forward Flow / (-) Reverse Flow. Aero-acoustic performance data based on NVLAP accredited laboratory tests conducted in strict accordance with ASTM E477-99.

TAKE NOTE!

- Silencer Face Area is the cross-sectional area at the silencer entrance
- Face Velocity is the CFM of airflow divided by the Face Area (in sq. ft.)
- Pressure Drop for any velocity can be calculated from this equation:
 $PD = (Actual\ FV/Catalog\ FV)^2 \times (Catalog\ PD)$
- Self Noise values shown are for a four-square-foot face area silencer
- For each doubling of the face area add 3 dB to the self-noise values listed
- For each halving of the face area subtract 3 dB from the self-noise values listed
- Weights and measures are listed for limited number of available sizes

Quiet-Duct Commercial Series Silencers

Type: S

Forward & Reverse Flow Ratings



The IAC Type S Quiet-Duct Silencers have been rated with procedures certified in accordance with applicable portions of ASTM E477. All Dynamic Insertion Loss and Self-Noise Acoustic Performance Data were obtained in a NVLAP accredited Aero-Acoustic Laboratory using the duct-to-room reverberant test facility **with air flowing through the silencers.**

Designating Silencers

Model: 5S 24 x 18

Type: S **Length:** 5' **Width:** 24" **Height:** 18"

Table I: Dynamic Insertion Loss (DIL) Ratings: Forward (+) / Reverse (-) Flow

IAC Model	Octave Band	1	2	3	4	5	6	7	8
	Hz	63	125	250	500	1K	2K	4K	8K
	Face Velocity, fpm	Dynamic Insertion Loss, dB							
3S	-2000	6	12	20	33	39	35	23	14
	-1000	5	11	17	33	38	35	25	14
	0	5	10	16	32	38	35	26	16
	1000	5	9	15	30	37	35	27	17
	2000	5	8	14	27	36	35	27	17
5S	-2000	10	20	27	45	48	43	36	22
	-1000	10	19	26	44	47	45	38	22
	0	9	17	25	43	47	46	39	24
	1000	7	17	23	42	46	46	40	25
	2000	6	16	22	40	46	46	40	25
7S	-2000	12	23	37	48	50	45	41	27
	-1000	12	22	35	47	49	47	44	28
	0	11	20	33	47	49	47	45	31
	1000	9	18	31	47	49	47	45	34
	2000	8	16	31	46	49	48	45	35
10S	-2000	14	26	43	50	51	50	45	37
	-1000	14	28	42	49	51	50	49	37
	0	13	25	42	49	52	50	49	41
	1000	12	22	41	49	52	50	49	44
	2000	11	19	40	50	52	50	49	46

(+) Forward Flow / (-) Reverse Flow. Aero-acoustic performance data based on NVLAP accredited laboratory tests conducted in strict accordance with ASTM E477-99. Contact IAC if attenuation in excess of 50 dB is required.

Table II: Weights & Measures

Nominal Length	W/In H/In	6	6	6	6	6	6	12	12	12	12	12	12	24	24	24
		18	24	30	36	42	48	18	24	30	36	42	48	18	24	30
3'	Wt/lb.	25	35	42	49	60	70	43	52	62	74	83	93	71	86	102
5'		44	63	75	87	105	126	73	89	107	125	141	158	121	147	173
7'		61	88	102	122	147	176	102	125	150	176	199	226	170	207	243
10'		86	123	150	171	206	246	155	177	212	250	N/A	N/A	241	293	345

Nominal Length	W/In H/In	24	24	24	36	36	36	36	36	36	48	48	48	48	48	48
		36	42	48	18	24	30	36	42	48	18	24	30	36	42	48
3'	Wt/lb.	117	132	147	81	102	142	162	182	204	142	172	204	234	264	294
5'		204	230	256	142	177.5	249	284	319	355	242	294	346	408	460	512
7'		288	325	362	207	244	293	330	N/A	N/A	340	414	486	576	650	724
10'		405	N/A	N/A	N/A	N/A	N/A	N/A	N/A	N/A	482	586	690	810	N/A	N/A

Table III: Aerodynamic Performance

IAC Model	L/Ft	Static Pressure Drop, i.w.g.															
		S	3'	0.01	0.03	0.06	0.09	0.13	0.18	0.23	0.29	0.36	0.44	0.52	0.61	0.71	0.82
5'	0.02		0.04	0.07	0.10	0.15	0.20	0.26	0.33	0.41	0.49	0.59	0.69	0.80	0.91	1.04	1.17
7'	0.02		0.04	0.07	0.11	0.16	0.21	0.28	0.35	0.44	0.53	0.63	0.74	0.85	0.98	1.11	1.26
10'	0.02		0.04	0.08	0.12	0.18	0.24	0.32	0.40	0.49	0.60	0.71	0.83	0.97	1.11	1.26	1.43
Silencer Face Velocity, fpm		200	300	400	500	600	700	800	900	1000	1100	1200	1300	1400	1500	1600	1700

Table IV: Self-Noise Power Levels, dB re: 10-12 Watts

IAC Model	Octave Band	1	2	3	4	5	6	7	8
	Hz	63	125	250	500	1K	2K	4K	8K
	Silencer Face Velocity, fpm								
S (all sizes)	-2000	68	62	61	66	61	64	67	66
	-1000	54	51	50	51	54	56	52	40
	-500	40	40	39	36	47	48	37	20
	500	36	29	35	30	31	35	22	20
	1000	55	49	49	47	46	49	42	32
	2000	74	69	63	64	61	63	62	56

(+) Forward Flow / (-) Reverse Flow. Aero-acoustic performance data based on NVLAP accredited laboratory tests conducted in strict accordance with ASTM E477-99.

TAKE NOTE!

- Silencer Face Area is the cross-sectional area at the silencer entrance
- Face Velocity is the CFM of airflow divided by the Face Area (in sq. ft.)
- Pressure Drop for any velocity can be calculated from this equation:
 $PD = (Actual\ FV/Catalog\ FV)^2 \times (Catalog\ PD)$
- Self Noise values shown are for a four-square-foot face area silencer
- For each doubling of the face area add 3 dB to the self-noise values listed
- For each halving of the face area subtract 3 dB from the self-noise values listed
- Weights and measures are listed for limited number of available sizes

Quiet-Duct Commercial Series Silencers

Type: ES

Forward & Reverse Flow Ratings



The IAC Type ES Quiet-Duct Silencers have been rated with procedures certified in accordance with applicable portions of ASTM E477. All Dynamic Insertion Loss and Self-Noise Acoustic Performance Data were obtained in a NVLAP accredited Aero-Acoustic Laboratory using the duct-to-room reverberant test facility **with air flowing through the silencers.**

For many years, the IAC Type S Quiet-Duct Silencer has been the industry standard for maximum noise reduction with minimum silencer length. The Type ES ("Energy Saver") Silencer provides the same high level of acoustic performance combined with a marked decrease in energy consumption.

Designating Silencers

Model: 5ES 24 x 18

Type: ES **Length:** 5' **Width:** 24" **Height:** 18"

Table I: Dynamic Insertion Loss (DIL) Ratings: Forward (+) / Reverse (-) Flow

IAC Model	Octave Band	1	2	3	4	5	6	7	8
	Hz	63	125	250	500	1K	2K	4K	8K
	Face Velocity, fpm	Dynamic Insertion Loss, dB							
3ES	-2000	5	8	18	31	38	36	22	16
	-1000	3	8	17	31	38	36	22	17
	0	3	6	16	29	38	35	22	18
	1000	2	5	14	27	36	34	23	17
	2000	2	5	12	25	34	34	23	18
5ES	-2000	10	16	25	41	52	48	26	17
	-1000	10	15	24	40	50	50	31	20
	0	9	12	22	38	51	50	33	22
	1000	7	12	19	37	51	49	35	23
	2000	6	12	19	35	49	49	35	24
7ES	-2000	11	20	39	53	51	53	37	21
	-1000	11	21	36	51	53	53	43	25
	0	10	19	33	50	53	53	46	29
	1000	7	16	31	50	53	52	46	32
	2000	6	15	29	48	54	50	48	34
10ES	-2000	15	31	40	53	54	53	43	24
	-1000	13	33	44	51	51	53	48	26
	0	11	28	43	52	52	53	49	32
	1000	9	25	41	52	51	54	49	37
	2000	7	24	38	53	51	54	50	39

(+) Forward Flow / (-) Reverse Flow. Aero-acoustic performance data based on NVLAP accredited laboratory tests conducted in strict accordance with ASTM E477-99. Contact IAC if attenuation in excess of 50 dB is required.

Table II: Weights & Measures

Nominal Length	W/In H/In	6	6	6	6	6	6	12	12	12	12	12	12	24	24	24
3'	Wt/lb.	25	35	42	49	60	70	43	52	62	74	83	93	71	86	102
5'		44	63	75	87	105	126	73	89	107	125	141	158	121	147	173
7'		61	88	102	122	147	176	102	125	150	176	199	226	170	207	243
10'		86	123	150	171	206	246	155	177	212	250	N/A	N/A	241	293	345

Nominal Length	W/In H/In	24	24	24	36	36	36	36	36	36	48	48	48	48	48	48
3'	Wt/lb.	117	132	147	81	102	142	162	182	204	142	172	204	234	264	294
5'		204	230	256	142	177.5	249	284	319	355	242	294	346	408	460	512
7'		288	325	362	207	244	293	330	N/A	N/A	340	414	486	576	650	724
10'		405	N/A	N/A	N/A	N/A	N/A	N/A	N/A	N/A	482	586	690	810	N/A	N/A

Table III: Aerodynamic Performance

IAC Model	L/Ft	Static Pressure Drop, i.w.g.															
ES	3'	0.01	0.02	0.04	0.06	0.08	0.11	0.14	0.18	0.22	0.27	0.32	0.37	0.43	0.50	0.57	0.64
	5'	0.01	0.02	0.04	0.06	0.09	0.12	0.15	0.19	0.24	0.29	0.34	0.40	0.46	0.53	0.60	0.68
	7'	0.01	0.03	0.05	0.08	0.12	0.17	0.22	0.28	0.34	0.41	0.49	0.57	0.67	0.76	0.87	0.98
	10'	0.02	0.04	0.07	0.11	0.16	0.22	0.28	0.36	0.44	0.54	0.64	0.75	0.87	1.00	1.13	1.28
Silencer Face Velocity, fpm		200	300	400	500	600	700	800	900	1000	1100	1200	1300	1400	1500	1600	1700

Table IV: Self-Noise Power Levels, dB re: 10-12 Watts

IAC Model	Octave Band	1	2	3	4	5	6	7	8
	Hz	63	125	250	500	1K	2K	4K	8K
	Silencer Face Velocity, fpm								
ES (all sizes)	-2000	56	54	58	60	61	65	69	64
	-1500	47	47	52	55	57	63	64	54
	-1000	41	41	45	47	52	60	48	38
	1000	42	35	33	32	34	33	27	22
	1500	50	47	44	41	43	45	43	41
	2000	60	57	54	50	49	53	53	50

(+) Forward Flow / (-) Reverse Flow. Aero-acoustic performance data based on NVLAP accredited laboratory tests conducted in strict accordance with ASTM E477-99.

TAKE NOTE!

- Silencer Face Area is the cross-sectional area at the silencer entrance
- Face Velocity is the CFM of airflow divided by the Face Area (in sq. ft.)
- Pressure Drop for any velocity can be calculated from this equation:
 $PD = (Actual\ FV/Catalog\ FV)^2 \times (Catalog\ PD)$
- Self Noise values shown are for a four-square-foot face area silencer
- For each doubling of the face area add 3 dB to the self-noise values listed
- For each halving of the face area subtract 3 dB from the self-noise values listed
- Weights and measures are listed for limited number of available sizes

Quiet-Duct Commercial Series Silencers

Type: MS

Forward & Reverse Flow Ratings

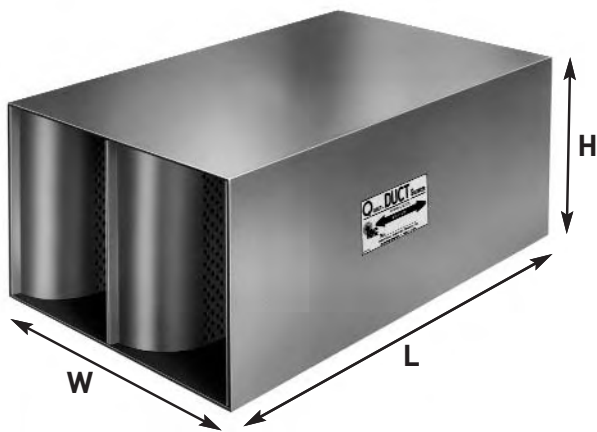

The IAC Type MS Quiet-Duct Silencers have been rated with procedures certified in accordance with applicable portions of ASTM E477. All Dynamic Insertion Loss and Self-Noise Acoustic Performance Data were obtained in a NVLAP accredited Aero-Acoustic Laboratory using the duct-to-room reverberant test facility **with air flowing through the silencers.**

The IAC Type MS Silencers provide superior performance with mid-range frequency from third thru sixth octave bands, where DIL have specific requirements in HVAC systems. In some applications high frequency attenuation may be provided by the system components or may not be needed.

Designating Silencers

Model: 5MS 30x18

Type: MS **Length:** 5' **Width:** 30" **Height:** 18"

Table I: Dynamic Insertion Loss (DIL) Ratings: Forward (+) / Reverse (-) Flow

IAC Model	Octave Band	1	2	3	4	5	6	7	8
	Hz	63	125	250	500	1K	2K	4K	8K
	Face Velocity, fpm	Dynamic Insertion Loss, dB							
3MS	-4000	5	7	14	24	27	20	12	9
	-2000	6	7	13	24	26	19	13	9
	0	5	7	13	23	25	20	15	10
	2000	4	6	12	21	24	21	16	11
	4000	3	5	11	18	23	22	17	11
5MS	-4000	7	12	21	38	43	32	19	10
	-2000	5	10	19	36	43	31	19	10
	0	5	10	18	35	43	32	21	12
	2000	4	9	17	34	42	33	22	14
	4000	3	8	16	32	40	34	22	15
7MS	-4000	8	17	28	41	46	41	24	13
	-2000	7	14	25	42	50	40	24	13
	0	7	14	24	42	50	42	26	15
	2000	7	13	23	41	49	44	28	17
	4000	6	11	21	40	49	45	30	19
10MS	-4000	12	21	35	43	52	47	31	18
	-2000	11	19	34	45	52	50	33	17
	0	11	18	33	45	52	51	36	19
	2000	10	17	32	45	51	52	38	21
	4000	9	14	29	44	48	50	40	23

(+) Forward Flow / (-) Reverse Flow. Aero-acoustic performance data based on NVLAP accredited laboratory tests conducted in strict accordance with ASTM E477-99. Contact IAC if attenuation in excess of 50 dB is required.

Table II: Weights & Measures

Nominal Length	W/In H/In	7.5	7.5	7.5	7.5	7.5	7.5	15	15	15	15	15	15	30	30	30
		18	24	30	36	42	48	18	24	30	36	42	48	18	24	30
3'	Wt/lb.	26	40	45	51	66	80	47	57	67	80	89	100	80	95	110
5'		46	67	80	91	112	134	80	96	114	134	150	167	135	161	187
7'		65	95	100	129	158	190	112	135	159	193	216	240	188	224	261
10'		90	135	157	180	223	270	159	192	226	273	N/A	N/A	220	319	371

Nominal Length	W/In H/In	30	30	30	45	45	45	45	45	45	60	60	60	60	60	60
		36	42	48	18	24	30	36	42	48	18	24	30	36	42	48
3'	Wt/lb.	130	145	160	127	152	156	177	197	218	160	190	220	260	290	320
5'		22	248	274	215	257	275	310	345	381	270	322	374	44	496	548
7'		310	347	384	300	359	N/A	N/A	N/A	N/A	376	448	522	620	694	768
10'		440	N/A	N/A	N/A	N/A	N/A	N/A	N/A	N/A	440	638	742	880	N/A	N/A

Table III: Aerodynamic Performance

IAC Model	L/Ft	Static Pressure Drop, i.w.g.															
		MS	3'	0.06	0.08	0.10	0.12	0.14	0.17	0.20	0.23	0.26	0.29	0.33	0.36	0.40	0.44
5'	0.08		0.10	0.12	0.15	0.17	0.20	0.24	0.27	0.31	0.35	0.39	0.44	0.48	0.53	0.58	0.64
7'	0.10		0.12	0.15	0.18	0.22	0.26	0.30	0.34	0.39	0.44	0.49	0.54	0.60	0.67	0.73	0.80
10'	0.12		0.15	0.19	0.23	0.27	0.31	0.36	0.42	0.48	0.54	0.60	0.67	0.74	0.82	0.90	0.98
Silencer Face Velocity, fpm		800	900	1000	1100	1200	1300	1400	1500	1600	1700	1800	1900	2000	2100	2200	2300

Table IV: Self-Noise Power Levels, dB re: 10-12 Watts

IAC Model	Octave Band	1	2	3	4	5	6	7	8
	Hz	63	125	250	500	1K	2K	4K	8K
	Silencer Face Velocity, fpm								
MS (all sizes)	-3000	67	63	61	66	61	64	67	67
	-2000	60	56	56	56	57	59	58	49
	-1000	46	45	45	41	50	51	43	23
	1000	44	32	36	34	31	32	29	21
	2000	63	54	52	50	47	48	47	44
	3000	74	64	60	58	56	58	59	57

(+) Forward Flow / (-) Reverse Flow. Aero-acoustic performance data based on NVLAP accredited laboratory tests conducted in strict accordance with ASTM E477-99.

TAKE NOTE!

- Silencer Face Area is the cross-sectional area at the silencer entrance
- Face Velocity is the CFM of airflow divided by the Face Area (in sq. ft.)
- Pressure Drop for any velocity can be calculated from this equation:
 $PD = (Actual\ FV/Catalog\ FV)^2 \times (Catalog\ PD)$
- Self Noise values shown are for a four-square-foot face area silencer
- For each doubling of the face area add 3 dB to the self-noise values listed
- For each halving of the face area subtract 3 dB from the self-noise values listed
- Weights and measures are listed for limited number of available sizes

Quiet-Duct Commercial Series Silencers

Type: LFL

Forward & Reverse Flow Ratings



Designating Silencers

Model: 5LFL 24x18

Type: LFL **Length:** 5' **Width:** 24" **Height:** 18"

The IAC Type LFL Quiet-Duct Silencers provide improved low frequency attenuation as well as low pressure drop aerodynamic performance. When third and fourth band performance is critical at the lowest available pressure drop, a Type LFL Quiet-Duct selection often results in a shorter silencer length than other equivalent silencer models.

Type LFL Quiet-Duct Silencers have been rated with procedures certified in accordance with applicable portions of ASTM E477. All Dynamic Insertion Loss and Self-Noise Acoustic Performance Data were obtained in a NVLAP accredited Aero-Acoustic Laboratory using the duct-to-room reverberant test facility **with air flowing through the silencers.**

Type LFL Silencers are advantageous where low frequency acoustic performance and low pressure drop aerodynamic performance are both essential to the HVAC system. In many applications higher frequency attenuation is provided by the system components or may not be needed.

Table I: Dynamic Insertion Loss (DIL) Ratings: Forward (+) / Reverse (-) Flow

IAC Model	Octave Band	1	2	3	4	5	6	7	8
	Hz	63	125	250	500	1K	2K	4K	8K
	Face Velocity, fpm	Dynamic Insertion Loss, dB							
3LFL	-2000	5	7	14	17	17	11	12	10
	-1000	4	7	13	17	17	11	11	10
	0	4	8	14	19	19	13	11	10
	1000	4	8	14	20	20	15	11	10
	2000	4	8	13	19	20	12	11	9
5LFL	-2000	6	12	19	27	28	15	15	13
	-1000	7	12	19	27	27	15	14	13
	0	7	11	18	26	26	15	13	12
	1000	6	10	17	24	25	14	12	11
	2000	5	10	16	23	25	14	12	11
7LFL	-2000	9	15	25	38	32	17	15	13
	-1000	9	14	24	38	32	17	15	14
	0	8	13	23	38	32	17	15	14
	1000	7	12	22	37	31	17	15	13
	2000	6	12	20	36	31	18	14	13
10LFL	-2000	12	20	32	43	42	20	18	15
	-1000	11	19	32	44	42	21	17	15
	0	11	18	31	44	42	21	17	15
	1000	10	17	29	44	41	21	17	15
	2000	9	16	27	44	41	21	16	15

(+) Forward Flow / (-) Reverse Flow. Aero-acoustic performance data based on NVLAP accredited laboratory tests conducted in strict accordance with ASTM E477-99. Contact IAC if attenuation in excess of 50 dB is required.

Table II: Weights & Measures

Nominal Length	W/In H/In	6	6	6	6	6	6	12	12	12	12	12	12	24	24	24
3'	Wt/lb.	18	21	25	29	31	35	35	42	50	57	61	70	54	64	74
5'		29	35	42	47	52	59	58	70	83	94	104	117	89	104	121
7'		41	49	59	67	75	83	82	98	118	134	150	166	125	146	175
10'		59	70	84	95	N/A	N/A	117	140	167	190	N/A	N/A	178	209	250

Nominal Length	W/In H/In	24	24	24	36	36	36	36	36	36	48	48	48	48	48	48
3'	Wt/lb.	82	92	102	89	106	124	139	153	172	108	128	148	164	184	204
5'		136	152	157	147	174	204	230	256	274	178	208	242	272	304	314
7'		196	218	240	207	244	293	330	N/A	N/A	N/A	N/A	N/A	N/A	N/A	N/A
10'		280	N/A	N/A	295	349	417	470	N/A	N/A	N/A	N/A	N/A	N/A	N/A	N/A

Table III: Aerodynamic Performance

IAC Model	L/Ft	Static Pressure Drop, i.w.g.															
LFL	3'	0.01	0.05	0.08	0.11	0.15	0.19	0.24	0.30	0.36	0.43	0.51	0.59	0.68	0.77	0.87	0.97
	5'	0.01	0.05	0.08	0.12	0.16	0.20	0.26	0.32	0.39	0.46	0.54	0.63	0.72	0.82	0.92	1.04
	7'	0.01	0.05	0.09	0.12	0.17	0.22	0.28	0.34	0.41	0.49	0.57	0.67	0.77	0.87	0.98	1.10
	10'	0.02	0.06	0.10	0.14	0.19	0.24	0.31	0.38	0.46	0.55	0.64	0.74	0.86	0.97	1.10	1.23
Silencer Face Velocity, fpm		400	800	1000	1200	1400	1600	1800	2000	2200	2400	2600	2800	3000	3200	3400	3600

Table IV: Self-Noise Power Levels, dB re: 10-12 Watts

IAC Model	Octave Band	1	2	3	4	5	6	7	8
	Hz	63	125	250	500	1K	2K	4K	8K
	Silencer Face Velocity, fpm								
LFL (all sizes)	-3000	55	54	56	57	56	59	61	56
	-2000	46	45	48	49	50	54	49	42
	-1000	31	30	34	35	40	45	28	20
	1000	32	24	32	25	34	39	24	20
	2000	47	42	46	44	46	51	46	38
	3000	56	53	54	55	53	58	59	53

(+) Forward Flow / (-) Reverse Flow. Aero-acoustic performance data based on NVLAP accredited laboratory tests conducted in strict accordance with ASTM E477-99.

TAKE NOTE!

- Silencer Face Area is the cross-sectional area at the silencer entrance
- Face Velocity is the CFM of airflow divided by the Face Area (in sq. ft.)
- Pressure Drop for any velocity can be calculated from this equation:
 $PD = (Actual\ FV/Catalog\ FV)^2 \times (Catalog\ PD)$
- Self Noise values shown are for a four-square-foot face area silencer
- For each doubling of the face area add 3 dB to the self-noise values listed
- For each halving of the face area subtract 3 dB from the self-noise values listed
- Weights and measures are listed for limited number of available sizes

Quiet-Duct Commercial Series Silencers

Type: ML

Forward & Reverse Flow Ratings



The IAC Type ML Quiet-Duct Silencers provide improved medium-low frequency attenuation as well as low pressure drop aerodynamic performance. When fourth and fifth band performance is critical at the lowest available pressure drop, a Type ML Quiet-Duct selection often results in a shorter silencer length than other equivalent silencer models.

Designating Silencers

Model: 5ML 36x18

Type: ML **Length:** 5' **Width:** 36" **Height:** 18"

Table I: Dynamic Insertion Loss (DIL) Ratings: Forward (+) / Reverse (-) Flow

IAC Model	Octave Band	1	2	3	4	5	6	7	8
	Hz	63	125	250	500	1K	2K	4K	8K
	Face Velocity, fpm	Dynamic Insertion Loss, dB							
3ML	-5000	4	5	12	20	18	11	7	5
	-2000	3	5	10	19	18	12	8	6
	0	3	5	10	19	18	12	9	7
	2000	3	4	9	18	17	12	9	8
	5000	2	4	8	16	17	13	10	9
5ML	-5000	6	9	18	32	32	17	9	6
	-2000	5	8	16	31	31	17	10	7
	0	5	8	15	31	31	19	12	9
	2000	4	7	14	30	30	20	13	10
	5000	3	6	14	28	29	22	13	11
7ML	-5000	6	12	22	42	43	24	14	10
	-2000	6	11	21	41	40	23	15	10
	0	6	11	20	39	40	25	16	11
	2000	5	10	19	37	39	26	16	12
	5000	5	9	17	36	38	28	16	12
10ML	-5000	9	18	28	46	47	34	19	11
	-2000	8	17	27	47	50	33	20	12
	0	8	16	26	46	50	35	20	12
	2000	7	15	25	45	49	36	20	12
	5000	7	15	23	44	50	36	21	14

(+) Forward Flow / (-) Reverse Flow. Aero-acoustic performance data based on NVLAP accredited laboratory tests conducted in strict accordance with ASTM E477-99. Contact IAC if attenuation in excess of 50 dB is required.

Table II: Weights & Measures

Nominal Length	W/In H/In	9	9	9	9	9	9	18	18	18	18	18	18	36	36	36
		18	24	30	36	42	48	18	24	30	36	42	48	18	24	30
3'	Wt/lb.	35	41	52	57	65	73	52	61	71	84	94	101	69	103	120
5'		60	71	82	95	107	119	87	103	121	142	158	175	120	175	201
7'		84	100	116	133	150	167	122	144	168	200	223	247	169	246	283
10'		118	141	167	190	240	215	174	205	239	284	N/A	N/A	238	349	403

Nominal Length	W/In H/In	36	36	36	54	54	54	54	54	54	72	72	72	72	72	72
		36	42	48	18	24	30	36	42	48	18	24	30	36	42	48
3'	Wt/lb.	138	153	168	121	164	191	222	247	272	138	206	240	276	306	336
5'		239	265	291	207	278	322	381	423	466	239	350	402	478	530	582
7'		337	374	411	291	390	451	537	597	658	337	492	566	674	748	822
10'		475	N/A	N/A	412	554	642	759	N/A	N/A	475	698	806	950	N/A	N/A

Table III: Aerodynamic Performance

IAC Model	L/Ft	Static Pressure Drop, i.w.g.															
		ML	3'	0.05	0.07	0.10	0.13	0.16	0.20	0.24	0.28	0.33	0.38	0.44	0.50	0.57	0.64
5'	0.06		0.08	0.12	0.15	0.19	0.24	0.28	0.34	0.40	0.46	0.53	0.60	0.68	0.76	0.85	0.94
7'	0.07		0.11	0.14	0.19	0.24	0.29	0.36	0.42	0.50	0.58	0.66	0.75	0.85	0.95	1.06	1.18
10'	0.09		0.13	0.18	0.23	0.29	0.36	0.44	0.52	0.61	0.71	0.82	0.93	1.05	1.18	1.31	1.45
Silencer Face Velocity, fpm		1000	1200	1400	1600	1800	2000	2200	2400	2600	2800	3000	3200	3400	3600	3800	4000

Table IV: Self-Noise Power Levels, dB re: 10-12 Watts

IAC Model	Octave Band	1	2	3	4	5	6	7	8
	Hz	63	125	250	500	1K	2K	4K	8K
	Silencer Face Velocity, fpm								
ML (all sizes)	-3000	64	59	59	63	60	62	63	59
	-2000	56	53	52	53	56	58	52	44
	-1000	42	42	41	38	49	50	37	20
	1000	39	35	30	27	26	28	28	20
	2000	58	52	46	43	42	45	45	39
	3000	71	61	55	53	51	55	56	52

(+) Forward Flow / (-) Reverse Flow. Aero-acoustic performance data based on NVLAP accredited laboratory tests conducted in strict accordance with ASTM E477-99.

TAKE NOTE!

- Silencer Face Area is the cross-sectional area at the silencer entrance
- Face Velocity is the CFM of airflow divided by the Face Area (in sq. ft.)
- Pressure Drop for any velocity can be calculated from this equation:
 $PD = (Actual\ FV/Catalog\ FV)^2 \times (Catalog\ PD)$
- Self Noise values shown are for a four-square-foot face area silencer
- For each doubling of the face area add 3 dB to the self-noise values listed
- For each halving of the face area subtract 3 dB from the self-noise values listed
- Weights and measures are listed for limited number of available sizes

Quiet-Duct Commercial Series Silencers

Type: L

Forward & Reverse Flow Ratings

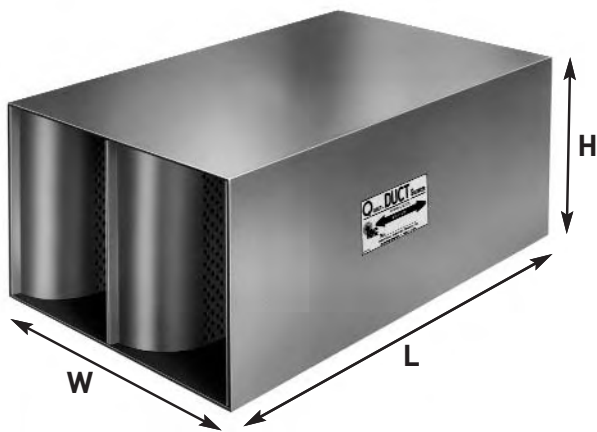

The IAC Type L Quiet-Duct Silencers provide excellent frequency attenuation as well as low pressure drop aerodynamic performance. When fifth and sixth band performance is critical at the lowest available pressure drop, a Type L Quiet-Duct selection often results in a shorter silencer length than other equivalent silencer models.

Designating Silencers

Model: 5L 24 x 18

Type: L **Length:** 5' **Width:** 24" **Height:** 18"

Table I: Dynamic Insertion Loss (DIL) Ratings: Forward (+) / Reverse (-) Flow

IAC Model	Octave Band	1	2	3	4	5	6	7	8
	Hz	63	125	250	500	1K	2K	4K	8K
	Face Velocity, fpm	Dynamic Insertion Loss, dB							
3L	-5000	4	7	10	16	23	18	12	7
	-2000	3	5	9	15	22	19	12	8
	0	3	5	9	15	22	21	13	9
	2000	3	5	8	14	21	22	13	9
	5000	2	4	7	13	19	22	14	10
5L	-5000	6	10	15	25	33	32	16	9
	-2000	5	8	14	24	32	32	16	10
	0	5	8	14	23	31	34	17	12
	2000	5	7	13	22	30	35	18	13
	5000	4	6	11	20	28	35	19	13
7L	-5000	7	15	20	33	42	39	21	12
	-2000	6	12	18	31	42	40	20	13
	0	6	12	17	30	41	42	21	14
	2000	6	11	16	29	39	43	22	15
	5000	5	8	15	28	37	43	24	16
10L	-5000	9	20	28	44	47	46	28	16
	-2000	9	16	25	42	48	48	28	17
	0	9	15	24	41	48	49	29	19
	2000	9	14	23	40	48	49	29	20
	5000	8	12	21	39	47	49	32	22

(+) Forward Flow / (-) Reverse Flow. Aero-acoustic performance data based on NVLAP accredited laboratory tests conducted in strict accordance with ASTM E477-99. Contact IAC if attenuation in excess of 50 dB is required.

Table II: Weights & Measures

Nominal Length	W/In H/In	6 18	6 24	6 30	6 36	6 42	6 48	12 18	12 24	12 30	12 36	12 42	12 48	24 18	24 24	24 30
3'	Wt/lb.	29	35	42	49	56	63	43	52	62	74	83	93	71	86	102
5'		52	63	75	87	99	111	73	89	107	125	141	158	121	147	173
7'		72	88	105	122	139	156	102	125	150	176	199	226	170	207	243
10'		101	123	147	171	163	187	155	177	212	25	N/A	N/A	241	293	345

Nominal Length	W/In H/In	24 36	24 42	24 48	36 18	36 24	36 30	36 36	36 42	36 48	48 18	48 24	48 30	48 36	48 42	48 48
3'	Wt/lb.	117	132	147	101	121	143	163	184	205	140	168	182	209	235	261
5'		204	230	256	180	211	245	279	312	346	242	284	312	353	395	438
7'		288	325	362	252	295	351	398	445	492	N/A	N/A	N/A	N/A	N/A	N/A
10'		405	N/A	N/A	N/A	N/A	N/A	N/A	N/A	N/A	N/A	N/A	N/A	N/A	N/A	N/A

Table III: Aerodynamic Performance

IAC Model	L/Ft	Static Pressure Drop, i.w.g.															
		L	3'	0.05	0.07	0.10	0.13	0.16	0.20	0.24	0.29	0.34	0.39	0.45	0.51	0.58	0.65
5'	0.06		0.08	0.11	0.14	0.18	0.22	0.27	0.32	0.37	0.43	0.50	0.56	0.64	0.71	0.79	0.88
7'	0.06		0.09	0.12	0.15	0.19	0.24	0.29	0.35	0.41	0.47	0.54	0.61	0.69	0.78	0.87	0.96
10'	0.07		0.10	0.13	0.17	0.22	0.27	0.33	0.39	0.46	0.53	0.61	0.69	0.78	0.87	0.97	1.08
Silencer Face Velocity, fpm		1000	1200	1400	1600	1800	2000	2200	2400	2600	2800	3000	3200	3400	3600	3800	4000

Table IV: Self-Noise Power Levels, dB re: 10-12 Watts

IAC Model	Octave Band	1	2	3	4	5	6	7	8
	Hz	63	125	250	500	1K	2K	4K	8K
	Silencer Face Velocity, fpm								
L (all sizes)	-3000	64	59	58	62	60	62	62	58
	-2000	55	52	52	53	56	56	56	43
	-1000	41	41	41	38	49	48	38	20
	1000	38	31	37	32	32	36	24	20
	2000	57	51	51	49	47	50	44	35
	3000	68	63	59	60	56	58	56	50

(+) Forward Flow / (-) Reverse Flow. Aero-acoustic performance data based on NVLAP accredited laboratory tests conducted in strict accordance with ASTM E477-99.

TAKE NOTE!

- Silencer Face Area is the cross-sectional area at the silencer entrance
- Face Velocity is the CFM of airflow divided by the Face Area (in sq. ft.)
- Pressure Drop for any velocity can be calculated from this equation:
 $PD = (Actual\ FV/Catalog\ FV)^2 \times (Catalog\ PD)$
- Self Noise values shown are for a four-square-foot face area silencer
- For each doubling of the face area add 3 dB to the self-noise values listed
- For each halving of the face area subtract 3 dB from the self-noise values listed
- Weights and measures are listed for limited number of available sizes

Quiet-Duct Clean-Flow™ Silencers

Section 15000 Specifications

1.01 General

- A. Furnish and install "Clean-Flow" (rectangular) silencers of the types and sizes shown on the plans and/or listed in the schedule. Silencers shall be the product of IAC Acoustics. Any specification change must be submitted in writing and approved by the Architect/Engineer, in writing, at least 10 days prior to the bid due-date.

2.01 Materials

- A. Outer casings of rectangular silencers shall be made of 22 gauge type #G-90 lock-former-quality galvanized steel.
- B. Interior partitions for rectangular silencers shall be not less than 26 gauge type #G-90 galvanized lock-former-quality perforated steel.
- C. Filler material shall be inorganic glass fiber of a proper density to obtain the specified acoustic performance and be packed under not less than 5% compression to eliminate voids due to vibration and settling. Material shall be inert, vermin- and moisture-proof. Filler material shall be totally encapsulated and sealed with polymeric film of an appropriate thickness. The encapsulated fill material shall be separated from the interior perforated baffles by means of a noncombustible, erosion resistant, factory-installed, acoustic stand-off. It shall not be acceptable to omit the acoustic stand-off and try to compensate for its absence by means of corrugated baffles.
- D. Combustion ratings for the silencer acoustic fill shall be not greater than the following when tested to ASTM E 84, NFPA Standard 255, or UL No. 723:

Flamespread Classification	20
Smoke Development Rating.....	20

3.01 Construction

- A. Units shall be constructed in accordance with the ASHRAE Guide recommendations for high pressure duct work. Seams shall be lock formed and mastic filled. Rectangular casing seams shall be in the corners of the silencer shell to provide maximum unit strength and rigidity. Interior partitions shall be fabricated from single-piece, margin-perforated sheets and shall have die-formed entrance and exit shapes so as to provide the maximum aerodynamic efficiency and minimum self-noise characteristics in the sound attenuator. Blunt noses or squared off partitions will not be accepted.
- B. Attachment of the interior partitions to the casing shall be by means of an interlocking track assembly. Tracks shall be solid galvanized steel and shall be welded to the outer casing. Attachment of the interior partitions to the tracks shall be such that a minimum of 4 thicknesses of metal exist at this location. The track assembly shall stiffen the exterior casing, provide a reinforced attachment detail for the interior partitions, and shall maintain a uniform airspace width along

the length of the silencer for consistent aerodynamic and acoustic performance. Interior partitions shall be additionally secured to the outer casing with welded nose clips at both ends of the sound attenuator.

- C. Sound attenuating units shall not fail structurally when subjected to a differential air pressure of 8 inches water gauge from inside to outside the casing. Airtight construction shall be provided by use of a duct sealing compound on the job-site material and labor furnished by the contractor.

4.01 Acoustic Performance

- A. All silencer ratings shall be determined in a duct-to-reverberant room test facility which provides for airflow in both directions through the test silencer in accordance with ASTM Specification E477-99. The test facility shall be NVLAP accredited for the ASTM E477-99 test standard. Data from a non-accredited laboratory will not be acceptable. The test set-up and procedure shall be such that all effects due to end reflection, directivity, flanking transmission, standing waves and test chamber sound absorption are eliminated.

Acoustic ratings shall include Dynamic Insertion Loss (DIL) and Self-Noise (SN) Power Levels both for FORWARD FLOW (air and noise in same direction) and REVERSE FLOW (air and noise in opposite directions) with airflow of at least 2000 fpm entering face velocity. Data for rectangular and tubular type silencers shall be presented for tests conducted using silencers no smaller than the following cross-sections:

Rectangular, inch: 24 x 24, 24 x 30, or 24 x 36
Tubular, inch: 12, 24, 36 and 48

5.01 Aerodynamic Performance

- A. Static pressure loss of silencers shall not exceed those listed in the silencer schedule as the airflow indicates. Airflow measurements shall be made in accordance with ASTM specification E477-99 and applicable portions of ASME, AMCA, and ADC airflow test codes. Tests shall be reported on the identical units for which acoustic data is presented.

6.01 Certification

- A. With submittals, the manufacturer shall supply certified test data on Dynamic Insertion Loss, Self-Noise Power Levels, and Aerodynamic Performance for Reverse and Forward Flow test conditions. Test data shall be for a standard product. All rating tests shall be conducted in the same facility, shall utilize the same silencer, and shall be open to inspection upon request from the Architect/Engineer.

7.01 Duct Transitions

- A. When transitions are required to adapt silencer dimensions to connecting duct work they shall be furnished by the installing contractor.

Quiet-Duct Clean-Flow™ Silencers

Type: HLFS

Forward & Reverse Flow Ratings



The IAC Type HLFS Clean-Flow Quiet-Duct Silencers provide superior low frequency attenuation for air handling systems requiring a high degree of cleanliness and hygiene. The non-erosive, non-pregnable, “Clean Flow” features make these silencers ideal for hospital, laboratory and clean-room type applications.

All HLFS Silencers have been rated with procedures certified in accordance with applicable portions of ASTM E477. All Dynamic Insertion Loss and Self-Noise Acoustic Performance Data were obtained in a NVLAP accredited Aero-Acoustic Laboratory using the duct-to-room reverberant test facility **with air flowing through the silencers.**

Type HLFS Silencers are advantageous where low frequency DIL requirements are high in HVAC systems. The acoustic fill is totally encapsulated to prevent erosion or entrainment of particulate. A honeycomb acoustic stand-off provides additional protection and performance.

Designating Silencers

Model: 5HLFS 24 x 18

Type: HLFS **Length:** 5' **Width:** 24" **Height:** 18"

Table I: Dynamic Insertion Loss (DIL) Ratings: Forward (+) / Reverse (-) Flow

IAC Model	Octave Band	1	2	3	4	5	6	7	8
	Hz	63	125	250	500	1K	2K	4K	8K
	Face Velocity, fpm	Dynamic Insertion Loss, dB							
3HLFS	-2000	7	13	15	20	19	18	16	10
	-1000	7	12	14	20	19	18	15	10
	0	9	14	15	21	19	18	15	11
	1000	7	11	14	20	18	15	15	10
	2000	7	11	14	18	17	16	14	9
5HLFS	-2000	11	18	22	26	25	21	19	13
	-1000	11	16	23	26	25	21	19	14
	0	12	16	23	27	25	21	19	14
	1000	12	16	23	26	25	20	18	14
	2000	13	15	22	25	24	20	17	13
7HLFS	-2000	14	17	23	29	31	29	22	16
	-1000	15	17	23	30	31	29	22	16
	0	15	18	23	28	29	27	20	15
	1000	15	18	22	25	27	24	18	14
	2000	15	20	23	26	26	23	17	13
10HLFS	-2000	17	24	29	35	38	37	28	19
	-1000	15	23	30	36	39	36	28	18
	0	15	23	30	34	38	37	27	19
	1000	15	23	30	34	38	37	27	18
	2000	17	22	28	34	37	37	28	18

(+) Forward Flow / (-) Reverse Flow. Aero-acoustic performance data based on NVLAP accredited laboratory tests conducted in strict accordance with ASTM E477-99. Contact IAC if attenuation in excess of 50 dB is required.

Table II: Weights & Measures

Nominal Length	W/In H/In	6	6	6	6	6	6	12	12	12	12	12	12	24	24	24
3'	Wt/lb.	18	21	25	29	31	35	35	42	50	57	61	70	54	64	74
5'		29	35	42	47	52	59	58	70	83	94	104	117	89	104	121
7'		41	49	59	67	75	83	82	98	118	134	150	166	125	146	175
10'		59	70	84	95	N/A	N/A	117	140	167	190	N/A	N/A	178	209	250

Nominal Length	W/In H/In	24	24	24	36	36	36	36	36	36	48	48	48	48	48	48
3'	Wt/lb.	82	92	102	89	106	124	139	153	172	108	128	148	164	184	204
5'		136	152	157	147	174	204	230	256	274	178	208	242	272	304	314
7'		196	218	240	207	244	293	330	N/A	N/A	N/A	N/A	N/A	N/A	N/A	N/A
10'		280	N/A	N/A	295	349	417	470	N/A	N/A	N/A	N/A	N/A	N/A	N/A	N/A

Table III: Aerodynamic Performance

IAC Model	L/Ft	Static Pressure Drop, i.w.g.															
HLFS	3'	0.04	0.05	0.07	0.09	0.11	0.14	0.17	0.20	0.24	0.28	0.32	0.36	0.41	0.46	0.51	0.57
	5'	0.04	0.06	0.08	0.10	0.13	0.16	0.19	0.22	0.26	0.31	0.35	0.40	0.45	0.51	0.56	0.62
	7'	0.04	0.06	0.08	0.10	0.13	0.16	0.20	0.23	0.28	0.32	0.37	0.42	0.47	0.53	0.59	0.65
	10'	0.04	0.06	0.09	0.11	0.14	0.18	0.21	0.26	0.30	0.35	0.40	0.45	0.51	0.57	0.64	0.71
Silencer Face Velocity, fpm		250	300	350	400	450	500	550	600	650	700	750	800	850	900	950	1000

Table IV: Self-Noise Power Levels, dB re: 10-12 Watts

IAC Model	Octave Band	1	2	3	4	5	6	7	8
	Hz	63	125	250	500	1K	2K	4K	8K
	Silencer Face Velocity, fpm								
HLFS (all sizes)	-2000	58	54	58	61	62	62	65	63
	-1500	51	49	53	56	56	59	60	53
	-1000	45	42	45	43	45	49	44	37
	1000	46	42	45	43	45	49	44	37
	1500	56	54	57	56	52	56	57	51
	2000	68	64	65	66	61	61	64	61

(+) Forward Flow / (-) Reverse Flow. Aero-acoustic performance data based on NVLAP accredited laboratory tests conducted in strict accordance with ASTM E477-99.

TAKE NOTE!

- Silencer Face Area is the cross-sectional area at the silencer entrance
- Face Velocity is the CFM of airflow divided by the Face Area (in sq. ft.)
- Pressure Drop for any velocity can be calculated from this equation:
 $PD = (Actual\ FV/Catalog\ FV)^2 \times (Catalog\ PD)$
- Self Noise values shown are for a four-square-foot face area silencer
- For each doubling of the face area add 3 dB to the self-noise values listed
- For each halving of the face area subtract 3 dB from the self-noise values listed
- Weights and measures are listed for limited number of available sizes

Quiet-Duct Clean-Flow™ Silencers

Type: HLFM

Forward & Reverse Flow Ratings



The IAC Type HLFM Clean-Flow Quiet-Duct Silencers provide improved low frequency attenuation with medium range pressure loss for air handling systems requiring a high degree of cleanliness and hygiene. The non-erosive, non-pregnable, “Clean Flow” features make these silencers ideal for hospital, laboratory and clean-room type applications.

All HLFM Silencers have been rated with procedures certified in accordance with applicable portions of ASTM E477. All Dynamic Insertion Loss and Self-Noise Acoustic Performance Data were obtained in a NVLAP Aero-Acoustic Laboratory using the duct-to-room reverberant test facility **with air flowing through the silencers.**

Type HLFM Silencers provide improved low frequency attenuation for medium velocity HVAC systems. The acoustic fill is totally encapsulated to prevent erosion or entrainment of particulate. A honeycomb acoustic stand-off provides additional protection and performance.

Designating Silencers

Model: 5HLFM 24 x 18

Type: HLFM **Length:** 5' **Width:** 24" **Height:** 18"

Table I: Dynamic Insertion Loss (DIL) Ratings: Forward (+) / Reverse (-) Flow

IAC Model	Octave Band	1	2	3	4	5	6	7	8
	Hz	63	125	250	500	1K	2K	4K	8K
	Face Velocity, fpm	Dynamic Insertion Loss, dB							
3HLFM	-2000	6	8	11	15	15	14	13	8
	-1000	6	8	11	15	15	13	12	8
	0	6	7	11	16	15	12	11	8
	1000	4	7	10	15	14	13	11	8
	2000	4	7	10	14	13	12	11	8
5HLFM	-2000	9	14	21	23	22	16	13	10
	-1000	8	13	21	23	23	16	13	10
	0	9	12	22	23	23	16	14	10
	1000	8	12	20	23	22	16	13	10
	2000	7	11	19	22	22	16	13	9
7HLFM	-2000	11	16	23	29	29	19	18	13
	-1000	11	16	24	29	29	19	19	14
	0	11	16	24	29	28	20	19	14
	1000	11	16	23	28	27	19	18	13
	2000	11	15	23	28	27	21	18	14
10HLFM	-2000	14	21	28	31	33	23	22	16
	-1000	14	21	28	31	32	24	23	17
	0	15	21	28	32	31	25	23	17
	1000	15	21	27	30	32	25	23	16
	2000	13	20	27	30	32	25	23	16

(+) Forward Flow / (-) Reverse Flow. Aero-acoustic performance data based on NVLAP accredited laboratory tests conducted in strict accordance with ASTM E477-99. Contact IAC if attenuation in excess of 50 dB is required.

Table II: Weights & Measures

Nominal Length	W/In H/In	6	6	6	6	6	6	12	12	12	12	12	12	24	24	24
3'	Wt/lb.	18	21	25	29	31	35	35	42	50	57	61	70	54	64	74
5'		29	35	42	47	52	59	58	70	83	94	104	117	89	104	121
7'		41	49	59	67	75	83	82	98	118	134	150	166	125	146	175
10'		59	70	84	95	N/A	N/A	117	140	167	190	N/A	N/A	178	209	250

Nominal Length	W/In H/In	24	24	24	36	36	36	36	36	36	48	48	48	48	48	48
3'	Wt/lb.	82	92	102	89	106	124	139	153	172	108	128	148	164	184	204
5'		136	152	157	147	174	204	230	256	274	178	208	242	272	304	314
7'		196	218	240	207	244	293	330	N/A	N/A	N/A	N/A	N/A	N/A	N/A	N/A
10'		280	N/A	N/A	295	349	417	470	N/A	N/A	N/A	N/A	N/A	N/A	N/A	N/A

Table III: Aerodynamic Performance

IAC Model	L/Ft	Static Pressure Drop, i.w.g.															
HLFM	3'	0.05	0.07	0.09	0.12	0.15	0.19	0.23	0.27	0.32	0.37	0.42	0.48	0.55	0.61	0.68	0.76
	5'	0.05	0.07	0.10	0.13	0.16	0.20	0.24	0.29	0.34	0.39	0.45	0.51	0.57	0.64	0.72	0.79
	7'	0.05	0.07	0.10	0.13	0.17	0.21	0.25	0.30	0.35	0.41	0.47	0.53	0.60	0.67	0.75	0.83
	10'	0.06	0.08	0.12	0.15	0.18	0.24	0.29	0.34	0.40	0.46	0.53	0.60	0.68	0.76	0.85	0.94
Silencer Face Velocity, fpm		500	600	700	800	900	1000	1100	1200	1300	1400	1500	1600	1700	1800	1900	2000

Table IV: Self-Noise Power Levels, dB re: 10-12 Watts

IAC Model	Octave Band	1	2	3	4	5	6	7	8
	Hz	63	125	250	500	1K	2K	4K	8K
	Silencer Face Velocity, fpm								
HLFM (all sizes)	-3000	64	62	64	66	65	64	66	62
	-2000	53	50	54	56	56	59	58	51
	-1000	42	40	43	45	47	46	37	27
	1000	47	34	36	35	40	37	27	20
	2000	54	52	58	56	51	56	55	50
	3000	68	64	64	63	61	63	66	63

(+) Forward Flow / (-) Reverse Flow. Aero-acoustic performance data based on NVLAP accredited laboratory tests conducted in strict accordance with ASTM E477-99.

TAKE NOTE!

- Silencer Face Area is the cross-sectional area at the silencer entrance
- Face Velocity is the CFM of airflow divided by the Face Area (in sq. ft.)
- Pressure Drop for any velocity can be calculated from this equation:
 $PD = (Actual\ FV/Catalog\ FV)^2 \times (Catalog\ PD)$
- Self Noise values shown are for a four-square-foot face area silencer
- For each doubling of the face area add 3 dB to the self-noise values listed
- For each halving of the face area subtract 3 dB from the self-noise values listed
- Weights and measures are listed for limited number of available sizes

Quiet-Duct Clean-Flow™ Silencers

Type: HS

Forward & Reverse Flow Ratings



Designating Silencers

Model: 5HS 24 x 18

Type: HS **Length:** 5' **Width:** 24" **Height:** 18"

The IAC Type HS Clean-Flow Quiet-Duct Silencers are designed for air handling systems requiring the ultimate in cleanliness and hygiene. They are:

- **Non-Erosive:** to eliminate carryover of inorganic particulate matter from the silencer.
- **Non-Pregnable:** to prevent or minimize the adsorption of gases and/or entry of Brownian particles into the fill.
- **Cleanable:**
 1. Non-removable fill permits periodic cleaning of exposed surfaces with soft brush vacuum cleaner.
 2. Optional removable parts also permit cleaning of concealed surfaces and replacement of acoustic fill.
- **Performance Rated:** Dynamic Insertion Loss (DIL), Self-Noise (SN) and Aerodynamic Ratings are given in Tables II, III and IV. All acoustic data are for forward and reverse flow.
- **Construction Materials:** Standard galvanized steel, polymer sheeting, acoustic infill and other materials. Special materials available on request.

Table I: Dynamic Insertion Loss (DIL) Ratings: Forward (+) / Reverse (-) Flow

IAC Model	Octave Band	1	2	3	4	5	6	7	8
	Hz	63	125	250	500	1K	2K	4K	8K
	Face Velocity, fpm	Dynamic Insertion Loss, dB							
3HS	-2000	7	12	15	22	26	30	28	14
	-1000	5	9	17	25	27	32	29	14
	0	5	7	15	33	26	30	19	14
	1000	5	6	13	21	24	28	29	13
	2000	5	8	11	17	21	26	31	13
5HS	-2000	14	15	22	27	35	42	33	15
	-1000	9	13	23	31	40	47	34	16
	0	8	11	22	29	38	46	34	16
	1000	8	12	18	28	36	44	34	14
	2000	8	12	16	23	32	40	33	15
7HS	-2000	15	18	23	31	45	49	34	13
	-1000	15	17	25	41	48	50	36	14
	0	13	15	22	39	48	50	38	15
	1000	11	12	19	38	49	50	38	17
	2000	11	11	16	31	45	50	35	16
10HS	-2000	20	22	30	34	49	50	33	11
	-1000	20	24	33	44	51	51	36	11
	0	17	20	31	42	52	51	38	15
	1000	14	16	27	40	51	50	39	19
	2000	14	17	24	34	48	50	36	17

(+) Forward Flow / (-) Reverse Flow. Aero-acoustic performance data based on NVLAP accredited laboratory tests conducted in strict accordance with ASTM E477-99. Contact IAC if attenuation in excess of 50 dB is required.

Table II: Weights & Measures

Nominal Length	W/In H/In	6 18	6 24	6 30	6 36	6 42	6 48	12 18	12 24	12 30	12 36	12 42	12 48	24 18	24 24	24 30
3'	Wt/lb.	25	35	42	49	60	70	43	52	62	74	83	93	71	86	102
5'		44	63	75	87	105	126	73	89	107	125	141	158	121	147	173
7'		61	88	102	122	147	176	102	125	150	176	199	226	170	207	243
10'		86	123	150	171	206	246	155	177	212	250	N/A	N/A	241	293	345

Nominal Length	W/In H/In	24 36	24 42	24 48	36 18	36 24	36 30	36 36	36 42	36 48	48 18	48 24	48 30	48 36	48 42	48 48
3'	Wt/lb.	117	132	147	81	102	142	162	182	204	142	172	204	234	264	294
5'		204	230	256	142	177.5	249	284	319	355	242	294	346	408	460	512
7'		288	325	362	N/A	N/A	N/A	N/A	N/A	N/A	340	414	486	576	650	724
10'		405	N/A	N/A	N/A	N/A	N/A	N/A	N/A	N/A	482	586	690	810	N/A	N/A

Table III: Aerodynamic Performance

IAC Model	L/Ft	Static Pressure Drop, i.w.g.															
		HS	3'	0.01	0.03	0.06	0.09	0.13	0.18	0.23	0.29	0.36	0.44	0.52	0.61	0.71	0.82
5'	0.02		0.04	0.07	0.10	0.15	0.20	0.26	0.33	0.41	0.49	0.59	0.69	0.80	0.91	1.04	1.17
7'	0.02		0.04	0.07	0.11	0.16	0.21	0.28	0.35	0.44	0.53	0.63	0.74	0.85	0.98	1.11	1.26
10'	0.02		0.04	0.08	0.12	0.18	0.24	0.32	0.40	0.49	0.60	0.71	0.83	0.97	1.11	1.26	1.43
Silencer Face Velocity, fpm		200	300	400	500	600	700	800	900	1000	1100	1200	1300	1400	1500	1600	1700

Table IV: Self-Noise Power Levels, dB re: 10-12 Watts

IAC Model	Octave Band	1	2	3	4	5	6	7	8
	Hz	63	125	250	500	1K	2K	4K	8K
	Silencer Face Velocity, fpm								
HS (all sizes)	-2000	68	62	61	66	61	64	67	66
	-1000	54	51	50	51	54	56	52	40
	-500	40	40	39	36	47	48	37	20
	500	36	29	35	30	31	35	22	20
	1000	55	49	49	47	46	49	42	32
	2000	74	69	63	64	61	63	62	56

(+) Forward Flow / (-) Reverse Flow. Aero-acoustic performance data based on NVLAP accredited laboratory tests conducted in strict accordance with ASTM E477-99.

TAKE NOTE!

- Silencer Face Area is the cross-sectional area at the silencer entrance
- Face Velocity is the CFM of airflow divided by the Face Area (in sq. ft.)
- Pressure Drop for any velocity can be calculated from this equation:
 $PD = (Actual\ FV/Catalog\ FV)^2 \times (Catalog\ PD)$
- Self Noise values shown are for a four-square-foot face area silencer
- For each doubling of the face area add 3 dB to the self-noise values listed
- For each halving of the face area subtract 3 dB from the self-noise values listed
- Weights and measures are listed for limited number of available sizes

Quiet-Duct Clean-Flow™ Silencers

Type: HMS

Forward & Reverse Flow Ratings



The IAC Type HMS Clean-Flow Quiet-Duct Silencers provide superior performance with mid-range frequency from third thru sixth octave bands and has significant pressure loss for air handling systems requiring a high degree of cleanliness and hygiene. The non-erosive, non-pregnable, “Clean Flow” features make these silencers ideal for hospital, laboratory and clean-room type applications.

All HMS Silencers have been rated with procedures certified in accordance with applicable portions of ASTM E477. All Dynamic Insertion Loss and Self-Noise Acoustic Performance Data were obtained in IAC’s Aero-Acoustic Laboratory using the duct-to-room reverberant test facility **with air flowing through the silencers.**

Designating Silencers

Model: 5HMS 24 x 18

Type: HMS **Length:** 5’ **Width:** 24” **Height:** 18”

Table I: Dynamic Insertion Loss (DIL) Ratings: Forward (+) / Reverse (-) Flow

IAC Model	Octave Band	1	2	3	4	5	6	7	8
	Hz	63	125	250	500	1K	2K	4K	8K
	Face Velocity, fpm	Dynamic Insertion Loss, dB							
3HMS	-4000	4	6	10	15	18	22	16	8
	-2000	5	6	9	15	17	21	17	8
	0	5	6	9	15	17	18	17	8
	2000	4	4	8	14	17	17	16	8
	4000	4	3	7	13	16	18	17	8
5HMS	-4000	6	10	15	29	29	30	23	9
	-2000	4	8	14	27	29	29	23	9
	0	4	9	13	25	29	28	23	10
	2000	3	7	11	24	27	27	22	12
	4000	3	6	10	22	28	28	22	12
7HMS	-4000	8	15	21	31	30	39	28	11
	-2000	7	12	18	33	35	38	28	11
	0	7	13	17	32	34	37	26	12
	2000	7	11	16	30	33	34	24	13
	4000	6	11	15	29	34	35	26	14
10HMS	-4000	11	14	25	30	36	40	32	15
	-2000	11	14	24	32	36	43	33	14
	0	12	14	23	33	35	41	30	15
	2000	10	12	23	32	34	40	28	16
	4000	9	13	21	31	32	37	30	18

(+) Forward Flow / (-) Reverse Flow. Aero-acoustic performance data based on NVLAP accredited laboratory tests conducted in strict accordance with ASTM E477-99. Contact IAC if attenuation in excess of 50 dB is required.

Table II: Weights & Measures

Nominal Length	W/In H/In	7.5	7.5	7.5	7.5	7.5	7.5	15	15	15	15	15	15	30	30	30
		18	24	30	36	42	48	18	24	30	36	42	48	18	24	30
3'	Wt/lb.	26	40	45	51	66	80	47	57	67	80	89	100	80	95	110
5'		46	67	80	91	112	134	80	96	114	134	150	167	135	161	187
7'		65	95	100	129	158	190	112	135	159	193	216	240	188	224	261
10'		90	135	157	180	223	270	159	192	226	273	N/A	N/A	220	319	371

Nominal Length	W/In H/In	30	30	30	45	45	45	45	45	45	60	60	60	60	60	60
		36	42	48	18	24	30	36	42	48	18	24	30	36	42	48
3'	Wt/lb.	130	145	160	127	152	156	177	197	218	160	190	220	260	290	320
5'		22	248	274	215	257	275	310	345	381	270	322	374	44	496	548
7'		310	347	384	300	359	N/A	N/A	N/A	N/A	376	448	522	620	694	768
10'		440	N/A	N/A	N/A	N/A	N/A	N/A	N/A	N/A	440	638	742	880	N/A	N/A

Table III: Aerodynamic Performance

IAC Model	L/Ft	Static Pressure Drop, i.w.g.															
		HMS	3'	0.06	0.08	0.10	0.12	0.14	0.17	0.20	0.23	0.26	0.29	0.33	0.36	0.40	0.44
5'	0.08		0.10	0.12	0.15	0.17	0.20	0.24	0.27	0.31	0.35	0.39	0.44	0.48	0.53	0.58	0.64
7'	0.10		0.12	0.15	0.18	0.22	0.26	0.30	0.34	0.39	0.44	0.49	0.54	0.60	0.67	0.73	0.80
10'	0.12		0.15	0.19	0.23	0.27	0.31	0.36	0.42	0.48	0.54	0.60	0.67	0.74	0.82	0.90	0.98
Silencer Face Velocity, fpm		800	900	1000	1100	1200	1300	1400	1500	1600	1700	1800	1900	2000	2100	2200	2300

Table IV: Self-Noise Power Levels, dB re: 10-12 Watts

IAC Model	Octave Band	1	2	3	4	5	6	7	8
	Hz	63	125	250	500	1K	2K	4K	8K
	Silencer Face Velocity, fpm								
HMS (all sizes)	-3000	67	63	61	66	61	64	67	67
	-2000	60	56	56	56	57	59	58	49
	-1000	46	45	45	41	50	51	43	23
	1000	44	32	36	34	31	32	29	21
	2000	63	54	52	50	47	48	47	44
	3000	74	64	60	58	56	58	59	57

(+) Forward Flow / (-) Reverse Flow. Aero-acoustic performance data based on NVLAP accredited laboratory tests conducted in strict accordance with ASTM E477-99.

TAKE NOTE!

- Silencer Face Area is the cross-sectional area at the silencer entrance
- Face Velocity is the CFM of airflow divided by the Face Area (in sq. ft.)
- Pressure Drop for any velocity can be calculated from this equation:
 $PD = (Actual\ FV/Catalog\ FV)^2 \times (Catalog\ PD)$
- Self Noise values shown are for a four-square-foot face area silencer
- For each doubling of the face area add 3 dB to the self-noise values listed
- For each halving of the face area subtract 3 dB from the self-noise values listed
- Weights and measures are listed for limited number of available sizes

Quiet-Duct Clean-Flow™ Silencers

Type: HLFL

Forward & Reverse Flow Ratings



The IAC Type HLFL Clean-Flow Quiet-Duct Silencers provide low frequency attenuation at reduced pressure loss for higher velocity HVAC systems requiring a high degree of cleanliness and hygiene. The non-erosive, non-pregnable, “Clean Flow” features make these silencers ideal for hospital, laboratory and clean-room type applications.

All HLFL Silencers have been rated with procedures certified in accordance with applicable portions of ASTM E477. All Dynamic Insertion Loss and Self-Noise Acoustic Performance Data were obtained in IAC’s Aero-Acoustic Laboratory using the duct-to-room reverberant test facility **with air flowing through the silencers.**

Type HLFL Silencers provide low frequency attenuation with low pressure drop for higher velocity HVAC systems. The acoustic fill is totally encapsulated to prevent erosion or entrainment of particulate. A honeycomb acoustic stand-off provides additional protection and performance.

Designating Silencers

Model: 5HLFL 24x18

Type: HLFL **Length:** 5’ **Width:** 24” **Height:** 18”

Table I: Dynamic Insertion Loss (DIL) Ratings: Forward (+) / Reverse (-) Flow

IAC Model	Octave Band	1	2	3	4	5	6	7	8
	Hz	63	125	250	500	1K	2K	4K	8K
	Face Velocity, fpm	Dynamic Insertion Loss, dB							
3HLFL	-2000	4	6	10	13	16	11	11	6
	-1000	3	6	9	13	16	11	10	7
	0	3	6	10	16	16	13	10	7
	1000	3	6	10	17	18	15	10	7
	2000	3	6	9	16	18	12	10	5
5HLFL	-2000	6	8	15	20	23	16	14	10
	-1000	7	9	15	20	23	17	13	10
	0	6	8	14	20	22	15	13	9
	1000	5	7	14	19	22	14	12	8
	2000	4	7	14	17	21	15	12	8
7HLFL	-2000	7	12	18	25	27	25	16	11
	-1000	6	12	17	26	27	25	17	12
	0	6	12	16	26	26	24	16	11
	1000	6	10	16	25	25	24	18	11
	2000	6	10	15	23	24	26	16	11
10HLFL	-2000	10	15	24	33	36	25	19	12
	-1000	8	15	24	35	36	26	18	12
	0	8	14	23	33	34	26	17	12
	1000	8	13	22	33	33	26	17	12
	2000	8	12	21	32	33	26	16	12

(+) Forward Flow / (-) Reverse Flow. Aero-acoustic performance data based on NVLAP accredited laboratory tests conducted in strict accordance with ASTM E477-99. Contact IAC if attenuation in excess of 50 dB is required.

Table II: Weights & Measures

Nominal Length	W/In H/In	6	6	6	6	6	6	12	12	12	12	12	12	24	24	24
3'	Wt/lb.	18	21	25	29	31	35	35	42	50	57	61	70	54	64	74
5'		29	35	42	47	52	59	58	70	83	94	104	117	89	104	121
7'		41	49	59	67	75	83	82	98	118	134	150	166	125	146	175
10'		59	70	84	95	N/A	N/A	117	140	167	190	N/A	N/A	178	209	250

Nominal Length	W/In H/In	24	24	24	36	36	36	36	36	36	48	48	48	48	48	48
3'	Wt/lb.	82	92	102	89	106	124	139	153	172	108	128	148	164	184	204
5'		136	152	157	147	174	204	230	256	274	178	208	242	272	304	314
7'		196	218	240	207	244	293	330	N/A	N/A	N/A	N/A	N/A	N/A	N/A	N/A
10'		280	N/A	N/A	295	349	417	470	N/A	N/A	N/A	N/A	N/A	N/A	N/A	N/A

Table III: Aerodynamic Performance

IAC Model	L/Ft	Static Pressure Drop, i.w.g.															
HLFL	3'	0.01	0.05	0.08	0.11	0.15	0.19	0.24	0.30	0.36	0.43	0.51	0.59	0.68	0.77	0.87	0.97
	5'	0.01	0.05	0.08	0.12	0.16	0.20	0.26	0.32	0.39	0.46	0.54	0.63	0.72	0.82	0.92	1.04
	7'	0.01	0.05	0.09	0.12	0.17	0.22	0.28	0.34	0.41	0.49	0.57	0.67	0.77	0.87	0.98	1.10
	10'	0.02	0.06	0.10	0.14	0.19	0.24	0.31	0.38	0.46	0.55	0.64	0.74	0.86	0.97	1.10	1.23
Silencer Face Velocity, fpm		400	800	1000	1200	1400	1600	1800	2000	2200	2400	2600	2800	3000	3200	3400	3600

Table IV: Self-Noise Power Levels, dB re: 10-12 Watts

IAC Model	Octave Band	1	2	3	4	5	6	7	8
	Hz	63	125	250	500	1K	2K	4K	8K
	Silencer Face Velocity, fpm								
HLFL (all sizes)	-3000	55	54	56	57	56	59	61	56
	-2000	46	45	48	49	50	54	49	42
	-1000	31	30	34	35	40	45	28	20
	1000	32	24	32	25	34	39	24	20
	2000	47	42	46	44	46	51	46	38
	3000	56	53	54	55	53	58	59	53

(+) Forward Flow / (-) Reverse Flow. Aero-acoustic performance data based on NVLAP accredited laboratory tests conducted in strict accordance with ASTM E477-99.

TAKE NOTE!

- Silencer Face Area is the cross-sectional area at the silencer entrance
- Face Velocity is the CFM of airflow divided by the Face Area (in sq. ft.)
- Pressure Drop for any velocity can be calculated from this equation:
 $PD = (Actual\ FV/Catalog\ FV)^2 \times (Catalog\ PD)$
- Self Noise values shown are for a four-square-foot face area silencer
- For each doubling of the face area add 3 dB to the self-noise values listed
- For each halving of the face area subtract 3 dB from the self-noise values listed
- Weights and measures are listed for limited number of available sizes

Quiet-Duct Clean-Flow™ Silencers

Type: HML

Forward & Reverse Flow Ratings



The IAC Type HML Clean-Flow Quiet-Duct Silencers provide improved medium-low frequency attenuation as well as low pressure drop aerodynamic performance in conjunction with the fourth and fifth octave bands needing critical low pressure loss for air handling systems requiring a high degree of cleanliness and hygiene. The non-erosive, non-pregnable, “Clean Flow” features make these silencers ideal for hospital, laboratory and clean-room type applications.

All HML Silencers have been rated with procedures certified in accordance with applicable portions of ASTM E477. All Dynamic Insertion Loss and Self-Noise Acoustic Performance Data were obtained in IAC’s Aero-Acoustic Laboratory using the duct-to-room reverberant test facility **with air flowing through the silencers.**

Designating Silencers

Model: 5HML 24 x 18

Type: HML **Length:** 5’ **Width:** 24” **Height:** 18”

Table I: Dynamic Insertion Loss (DIL) Ratings: Forward (+) / Reverse (-) Flow

IAC Model	Octave Band	1	2	3	4	5	6	7	8
	Hz	63	125	250	500	1K	2K	4K	8K
	Face Velocity, fpm	Dynamic Insertion Loss, dB							
3HML	-5000	4	4	7	14	12	7	8	4
	-2000	3	4	7	13	12	8	8	4
	0	3	4	7	13	12	7	9	5
	2000	3	2	6	12	11	8	9	6
	5000	2	3	6	11	11	8	10	
5HML	-5000	5	7	12	25	25	11	7	5
	-2000	4	6	12	23	24	11	8	5
	0	4	6	11	23	24	13	10	7
	2000	3	5	10	22	23	15	12	9
	5000	3	6	10	20	24	14	12	9
7HML	-5000	5	9	16	30	30	18	16	10
	-2000	6	8	15	29	31	17	15	9
	0	6	9	14	27	31	18	16	10
	2000	5	7	12	24	31	21	16	11
	5000	5	7	10	25	29	21	16	11
10HML	-5000	9	12	20	32	34	24	15	12
	-2000	8	12	19	33	37	23	16	12
	0	9	12	18	31	36	25	16	12
	2000	7	11	17	31	35	26	17	12
	5000	8	10	17	32	36	26	17	14

(+) Forward Flow / (-) Reverse Flow. Aero-acoustic performance data based on NVLAP accredited laboratory tests conducted in strict accordance with ASTM E477-99. Contact IAC if attenuation in excess of 50 dB is required.

Table II: Weights & Measures

Nominal Length	W/In H/In	9	9	9	9	9	9	18	18	18	18	18	18	36	36	36
		18	24	30	36	42	48	18	24	30	36	42	48	18	24	30
3'	Wt/lb.	35	41	52	57	65	73	52	61	71	84	94	104	69	103	120
5'		60	71	82	95	107	119	87	103	121	142	158	175	119.5	175	201
7'		84	100	116	133	150	167	122	144	168	200	223	247	168.5	246	283
10'		118	141	167	190	240	215	174	205	239	284	N/A	N/A	237.5	349	403

Nominal Length	W/In H/In	36	36	36	54	54	54	54	54	54	72	72	72	72	72	72
		36	42	48	18	24	30	36	42	48	18	24	30	36	42	48
3'	Wt/lb.	138	153	168	121	164	191	222	247	272	138	206	240	276	306	336
5'		239	265	291	206.5	278	322	381	423	466	239	350	402	478	530	582
7'		337	374	411	290.5	390	451	537	597	658	337	492	566	674	748	822
10'		475	N/A	N/A	411.5	554	642	759	N/A	N/A	475	698	806	950	N/A	N/A

Table III: Aerodynamic Performance

IAC Model	L/Ft	Static Pressure Drop, i.w.g.															
		HML	3'	0.05	0.07	0.10	0.13	0.16	0.20	0.24	0.28	0.33	0.38	0.44	0.50	0.57	0.64
5'	0.06		0.08	0.12	0.15	0.19	0.24	0.28	0.34	0.40	0.46	0.53	0.60	0.68	0.76	0.85	0.94
7'	0.07		0.11	0.14	0.19	0.24	0.29	0.36	0.42	0.50	0.58	0.66	0.75	0.85	0.95	1.06	1.18
10'	0.09		0.13	0.18	0.23	0.29	0.36	0.44	0.52	0.61	0.71	0.82	0.93	1.05	1.18	1.31	1.45
Silencer Face Velocity, fpm		1000	1200	1400	1600	1800	2000	2200	2400	2600	2800	3000	3200	3400	3600	3800	4000

Table IV: Self-Noise Power Levels, dB re: 10-12 Watts

IAC Model	Octave Band	1	2	3	4	5	6	7	8
	Hz	63	125	250	500	1K	2K	4K	8K
	Silencer Face Velocity, fpm								
HML (all sizes)	-3000	64	59	59	63	60	62	63	59
	-2000	56	53	52	53	56	58	52	44
	-1000	42	42	41	38	49	50	37	20
	1000	39	35	30	27	26	28	28	20
	2000	58	52	46	43	42	45	45	39
	3000	71	61	55	53	51	55	56	52

(+) Forward Flow / (-) Reverse Flow. Aero-acoustic performance data based on NVLAP accredited laboratory tests conducted in strict accordance with ASTM E477-99.

TAKE NOTE!

- Silencer Face Area is the cross-sectional area at the silencer entrance
- Face Velocity is the CFM of airflow divided by the Face Area (in sq. ft.)
- Pressure Drop for any velocity can be calculated from this equation:
 $PD = (Actual\ FV/Catalog\ FV)^2 \times (Catalog\ PD)$
- Self Noise values shown are for a four-square-foot face area silencer
- For each doubling of the face area add 3 dB to the self-noise values listed
- For each halving of the face area subtract 3 dB from the self-noise values listed
- Weights and measures are listed for limited number of available sizes

Quiet-Duct Clean-Flow™ Silencers

Type: HL

Forward & Reverse Flow Ratings



The IAC Type HL Clean-Flow Quiet-Duct Silencers provide excellent frequency attenuation as well as low pressure drop aerodynamic performance in conjunction with the fifth and sixth octave bands needing critical low pressure loss for air handling systems requiring a high degree of cleanliness and hygiene. The non-erosive, non-pregnable, “Clean Flow” features make these silencers ideal for hospital, laboratory and clean-room type applications.

All HL Silencers have been rated with procedures certified in accordance with applicable portions of ASTM E477. All Dynamic Insertion Loss and Self-Noise Acoustic Performance Data were obtained in IAC’s Aero-Acoustic Laboratory using the duct-to-room reverberant test facility **with air flowing through the silencers.**

Designating Silencers

Model: 5HL 24 x 18

Type: HL **Length:** 5’ **Width:** 24” **Height:** 18”

Table I: Dynamic Insertion Loss (DIL) Ratings: Forward (+) / Reverse (-) Flow

IAC Model	Octave Band	1	2	3	4	5	6	7	8
	Hz	63	125	250	500	1K	2K	4K	8K
	Face Velocity, fpm	Dynamic Insertion Loss, dB							
3HL	-5000	1	2	3	8	9	20	17	10
	-2000	2	3	3	8	8	19	17	9
	0	3	4	4	8	8	18	17	8
	2000	2	4	3	7	7	17	17	6
	5000	2	4	3	5	4	12	16	5
5HL	-5000	5	9	12	18	25	32	26	10
	-2000	5	8	10	17	24	37	23	10
	0	5	8	10	16	22	36	22	10
	2000	4	6	7	15	20	33	22	9
	5000	4	5	6	11	16	28	23	8
7HL	-5000	5	10	13	21	27	32	20	10
	-2000	6	7	10	19	25	42	21	10
	0	6	8	10	18	24	41	21	9
	2000	5	7	9	16	20	38	21	8
	5000	4	6	6	13	17	32	22	8
10HL	-5000	7	12	16	26	28	30	18	9
	-2000	9	8	12	24	29	44	20	9
	0	9	8	12	23	29	46	20	9
	2000	8	6	11	22	28	47	20	8
	5000	5	6	7	18	23	40	21	9

(+) Forward Flow / (-) Reverse Flow. Aero-acoustic performance data based on NVLAP accredited laboratory tests conducted in strict accordance with ASTM E477-99. Contact IAC if attenuation in excess of 50 dB is required.

Table II: Weights & Measures

Nominal Length	W/In H/In	6 18	6 24	6 30	6 36	6 42	6 48	12 18	12 24	12 30	12 36	12 42	12 48	24 18	24 24	24 30
3'	Wt/lb.	29	35	42	49	56	63	43	52	62	74	83	93	71	86	102
5'		52	63	75	87	99	111	73	89	107	125	141	158	121	147	173
7'		72	88	105	122	139	156	102	125	150	176	199	226	170	207	243
10'		101	123	147	171	163	187	155	177	212	25	N/A	N/A	241	293	345

Nominal Length	W/In H/In	24 36	24 42	24 48	36 18	36 24	36 30	36 36	36 42	36 48	48 18	48 24	48 30	48 36	48 42	48 48
3'	Wt/lb.	117	132	147	101	121	143	163	184	205	140	168	182	209	235	261
5'		204	230	256	180	211	245	279	312	346	242	284	312	353	395	438
7'		288	325	362	252	295	351	398	445	492	N/A	N/A	N/A	N/A	N/A	N/A
10'		405	N/A	N/A	N/A	N/A	N/A	N/A	N/A	N/A	N/A	N/A	N/A	N/A	N/A	N/A

Table III: Aerodynamic Performance

IAC Model	L/Ft	Static Pressure Drop, i.w.g.															
HL	3'	0.05	0.07	0.10	0.13	0.16	0.20	0.24	0.29	0.34	0.39	0.45	0.51	0.58	0.65	0.72	0.80
	5'	0.06	0.08	0.11	0.14	0.18	0.22	0.27	0.32	0.37	0.43	0.50	0.56	0.64	0.71	0.79	0.88
	7'	0.06	0.09	0.12	0.15	0.19	0.24	0.29	0.35	0.41	0.47	0.54	0.61	0.69	0.78	0.87	0.96
	10'	0.07	0.10	0.13	0.17	0.22	0.27	0.33	0.39	0.46	0.53	0.61	0.69	0.78	0.87	0.97	1.08
Silencer Face Velocity, fpm		1000	1200	1400	1600	1800	2000	2200	2400	2600	2800	3000	3200	3400	3600	3800	4000

Table IV: Self-Noise Power Levels, dB re: 10-12 Watts

IAC Model	Octave Band	1	2	3	4	5	6	7	8
	Hz	63	125	250	500	1K	2K	4K	8K
	Silencer Face Velocity, fpm								
HL (all sizes)	-3000	64	59	58	62	60	62	62	58
	-2000	55	52	52	53	56	56	56	43
	-1000	41	41	41	38	49	48	38	20
	1000	38	31	37	32	32	36	24	20
	2000	57	51	51	49	47	50	44	35
	3000	68	63	59	60	56	58	56	50

(+) Forward Flow / (-) Reverse Flow. Aero-acoustic performance data based on NVLAP accredited laboratory tests conducted in strict accordance with ASTM E477-99.

TAKE NOTE!

- Silencer Face Area is the cross-sectional area at the silencer entrance
- Face Velocity is the CFM of airflow divided by the Face Area (in sq. ft.)
- Pressure Drop for any velocity can be calculated from this equation:
 $PD = (Actual\ FV/Catalog\ FV)^2 \times (Catalog\ PD)$
- Self Noise values shown are for a four-square-foot face area silencer
- For each doubling of the face area add 3 dB to the self-noise values listed
- For each halving of the face area subtract 3 dB from the self-noise values listed
- Weights and measures are listed for limited number of available sizes

Quiet-Duct Conic-Flow® Silencers

Section 15000 Specifications

1.01 General

- A. Furnish and install "Conic-Flow" (tubular) silencers of the types and sizes shown on the plans and/or listed in the schedule. Silencers shall be the product of IAC Acoustics. Any specification change must be submitted in writing and approved by the Architect/Engineer, in writing, at least 10 days prior to the bid due-date.

2.01 Materials

- A. Outer casings of tubular silencers shall be made of type #G-90 lock-former-quality galvanized steel in the following gauges:

Outside Diamer, In.	Metal Gauge	Outside Diameter, In.	Metal Gauge
12-36	22	38-60	18

- B. Interior construction of tubular silencers shall be compatible with the respective outside casing.
- C. Filler material shall be inorganic glass fiber of a proper density to obtain the specified acoustic performance and be packed under not less than 5% compression to eliminate voids due to vibration and settling. Material shall be inert, vermin- and moisture-proof.
- D. Combustion ratings for the silencer acoustic fill shall be not greater than the following when tested to ASTM E 84, NFPA Standard 255, or UL No. 723:

Flamespread Classification	20
Smoke Development Rating.....	20

3.01 Construction

- A. Units shall be constructed in accordance with the ASHRAE Guide recommendations for high pressure duct work. Seams shall be lock formed and mastic filled. Rectangular casing seams shall be in the corners of the silencer shell to provide maximum unit strength and rigidity. Interior partitions shall be fabricated from single-piece, margin-perforated sheets and shall have die-formed entrance and exit shapes so as to provide the maximum aerodynamic efficiency and minimum self-noise characteristics in the sound attenuator. Blunt noses or squared off partitions will not be accepted.
- B. Interior partitions for tubular silencers shall be secured with galvanized steel radial mounting brackets welded to the partition and the outer casing. The radial brackets shall be installed full length and at 120 degree angles to each other to assure uniform spacing for consistent aerodynamic and acoustic performance.
- C. Sound attenuating units shall not fail structurally when subjected to a differential air pressure of 8 inches water gauge from inside to outside the casing. Airtight construction shall be provided by use of a duct sealing compound on the job-site material and labor furnished by the contractor.

4.01 Acoustic Performance

- A. All silencer ratings shall be determined in a duct-to-reverberant room test facility which provides for airflow in both directions through the test silencer in accordance with ASTM Specification E477-99. The test facility shall be NVLAP accredited for the ASTM E477-99 test standard. Data from a non-accredited laboratory will not be acceptable. The test set-up and procedure shall be such that all effects due to end reflection, directivity, flanking transmission, standing waves and test chamber sound absorption are eliminated.

Acoustic ratings shall include Dynamic Insertion Loss (DIL) and Self-Noise (SN) Power Levels both for FORWARD FLOW (air and noise in same direction) and REVERSE FLOW (air and noise in opposite directions) with airflow of at least 2000 fpm entering face velocity. Data for rectangular and tubular type silencers shall be presented for tests conducted using silencers no smaller than the following cross-sections:

Rectangular, inch: 24 x 24, 24 x 30, or 24 x 36
Tubular, inch: 12, 24, 36 and 48

5.01 Aerodynamic Performance

- A. Static pressure loss of silencers shall not exceed those listed in the silencer schedule as the airflow indicates. Airflow measurements shall be made in accordance with ASTM specification E477-99 and applicable portions of ASME, AMCA, and ADC airflow test codes. Tests shall be reported on the identical units for which acoustic data is presented.

6.01 Certification

- A. With submittals, the manufacturer shall supply certified test data on Dynamic Insertion Loss, Self-Noise Power Levels, and Aerodynamic Performance for Reverse and Forward Flow test conditions. Test data shall be for a standard product. All rating tests shall be conducted in the same facility, shall utilize the same silencer, and shall be open to inspection upon request from the Architect/Engineer.

7.01 Duct Transitions

- A. When transitions are required to adapt silencer dimensions to connecting duct work they shall be furnished by the installing contractor.

Low Frequency Conic-Flow® Silencers

Type: FCS

Forward & Reverse Flow Ratings

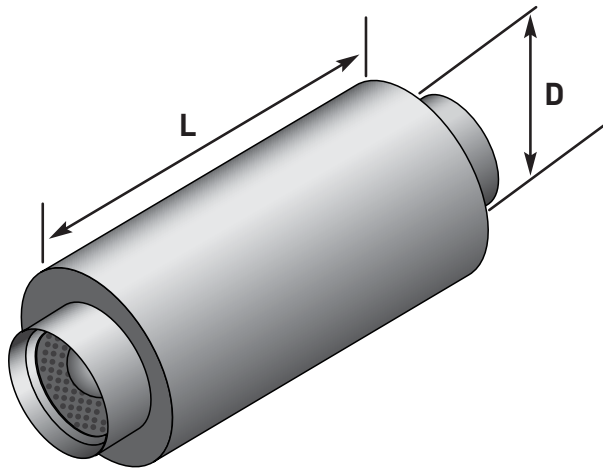

The IAC Type FCS Conic-Flow Silencers have been rated with procedures certified in accordance with applicable portions of ASTM E477. All Dynamic Insertion Loss and Self-Noise Acoustic Performance Data were obtained in a NVLAP accredited Aero-Acoustic Laboratory using the duct-to-room reverberant test facility **with air flowing through the silencers.**

Designating Silencers

Model: 12 FCS 36

Type: FCS **Diameter:** 12" **Length:** 36"

Table I: Dynamic Insertion Loss (DIL) Ratings: Forward (+) / Reverse (-) Flow

IAC Model	Octave Band	1	2	3	4	5	6	7	8
	Hz	63	125	250	500	1K	2K	4K	8K
	Face Velocity, fpm	Dynamic Insertion Loss, dB							
12FCS	-4000	10	18	29	42	40	35	31	21
	-2000	10	17	27	39	38	35	32	26
	0	10	16	26	36	36	36	33	26
	2000	9	14	24	33	34	37	34	27
	4000	8	12	22	29	33	39	35	27
24FCS	-4000	10	18	31	41	42	35	21	15
	-2000	10	16	29	38	40	35	22	17
	0	9	15	27	36	38	36	22	18
	2000	8	13	25	32	37	35	23	19
	4000	7	12	23	29	35	35	23	20
36FCS	-4000	12	21	35	41	40	27	19	14
	-2000	11	20	33	38	39	27	21	14
	0	10	18	31	37	38	27	22	15
	2000	9	16	29	35	36	28	23	16
	4000	8	14	27	33	34	28	24	17
48FCS	-4000	15	25	39	41	37	23	15	11
	-2000	13	22	37	39	36	23	17	12
	0	12	20	35	37	36	24	19	16
	2000	10	18	33	35	35	24	20	16
	4000	9	16	30	34	35	25	21	17
60FCS	-4000	18	30	43	41	35	16	12	10
	-2000	16	27	41	40	34	17	13	11
	0	14	25	39	39	33	19	15	13
	2000	12	22	37	37	33	20	16	15
	4000	10	20	34	35	33	22	18	16

(+) Forward Flow / (-) Reverse Flow. Aero-acoustic performance data based on NVLAP accredited laboratory tests conducted in strict accordance with ASTM E477-99. Contact IAC if attenuation in excess of 50 dB is required.

Table II: Weights & Measures

Model	Duct Diameter, Inches	12	14	16	18	20	22	24	26
	Silencer Length, Inches	36	36	36	36	40	44	48	52
FCS	Weight, lb.	99	111	132	149	168	188	208	234

Model	Duct Diameter, Inches	28	30	32	36	40	44	48	60
	Silencer Length, Inches	56	60	64	72	80	88	96	120
FCS	Weight, lb.	255	374	495	600	746	951	1140	1873

Table III: Aerodynamic Performance

IAC Model	L/Ft	Static Pressure Drop, i.w.g.																
		All Sizes	0.04	0.06	0.07	0.10	0.12	0.15	0.19	0.22	0.26	0.30	0.34	0.39	0.44	0.50	0.55	0.61
FCS																		
Silencer Face Velocity, fpm		1000	1200	1400	1600	1800	2000	2200	2400	2600	2800	3000	3200	3400	3600	3800	4000	

Table IV: Self-Noise Power Levels, dB re: 10-12 Watts

IAC Model	Octave Band	1	2	3	4	5	6	7	8
	Hz	63	125	250	500	1K	2K	4K	8K
	Silencer Face Velocity, fpm								
FCS (all sizes)	-3000	57	58	58	57	56	57	56	52
	-2000	50	49	51	49	46	47	45	39
	-1000	38	34	39	35	29	30	26	20
	1000	44	43	37	37	38	38	20	20
	2000	56	54	50	50	50	50	41	31
	3000	63	60	57	57	57	57	53	47

(+) Forward Flow / (-) Reverse Flow. Aero-acoustic performance data based on NVLAP accredited laboratory tests conducted in strict accordance with ASTM E477-99.

TAKE NOTE!

- Silencer Face Area is the cross-sectional area at the silencer entrance
- Face Velocity is the CFM of airflow divided by the Face Area (in sq. ft.)
- Pressure Drop for any velocity can be calculated from this equation:
 $PD = (\text{Actual FV}/\text{Catalog FV})^2 \times (\text{Catalog PD})$
- Self Noise values shown are for a four-square-foot face area silencer
- For each doubling of the face area add 3 dB to the self-noise values listed
- For each halving of the face area subtract 3 dB from the self-noise values listed
- Weights and measures are listed for limited number of available sizes

Low Frequency Conic-Flow® Silencers

Type: FCL

Forward & Reverse Flow Ratings

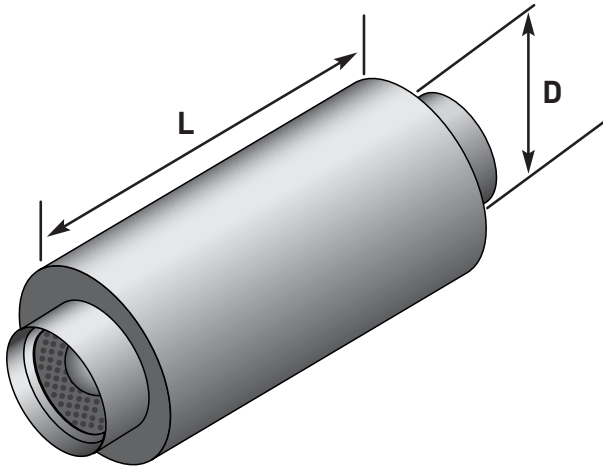

The IAC Type FCL Conic-Flow Silencers have been rated with procedures certified in accordance with applicable portions of ASTM E477. All Dynamic Insertion Loss and Self-Noise Acoustic Performance Data were obtained in a NVLAP accredited Aero-Acoustic Laboratory using the duct-to-room reverberant test facility **with air flowing through the silencers.**

Designating Silencers

Model: 12 FCL 36

Type: FCL **Diameter:** 12" **Length:** 36"

Table I: Dynamic Insertion Loss (DIL) Ratings: Forward (+) / Reverse (-) Flow

IAC Model	Octave Band	1	2	3	4	5	6	7	8
	Hz	63	125	250	500	1K	2K	4K	8K
	Face Velocity, fpm	Dynamic Insertion Loss, dB							
12FCL	-4000	8	17	25	30	35	34	23	18
	-2000	8	16	23	29	34	34	25	19
	0	8	15	22	27	33	31	26	21
	2000	8	14	20	25	32	27	26	23
	4000	7	12	18	23	31	29	27	23
24FCL	-4000	9	16	26	31	35	21	15	12
	-2000	9	15	24	29	33	21	16	13
	0	8	14	23	28	34	23	19	15
	2000	7	13	21	26	34	25	21	16
	4000	6	12	20	24	32	25	21	17
36FCL	-4000	11	20	29	33	30	20	17	12
	-2000	10	19	28	33	29	21	18	13
	0	9	17	26	32	29	23	19	15
	2000	8	15	24	31	29	25	20	16
	4000	7	13	22	30	28	25	20	16
48FCL	-4000	12	22	33	37	30	17	13	11
	-2000	12	20	31	36	30	18	15	13
	0	11	19	29	35	30	20	17	15
	2000	9	17	27	33	29	22	18	16
	4000	9	16	24	32	28	23	18	17
60FCL	-4000	15	26	36	38	29	15	11	10
	-2000	14	24	34	37	29	16	12	11
	0	13	22	33	36	28	19	15	14
	2000	11	20	31	35	27	21	17	16
	4000	10	18	28	35	26	20	17	17

(+) Forward Flow / (-) Reverse Flow. Aero-acoustic performance data based on NVLAP accredited laboratory tests conducted in strict accordance with ASTM E477-99. Contact IAC if attenuation in excess of 50 dB is required.

Table II: Weights & Measures

Model	Duct Diameter, Inches	12	14	16	18	20	22	24	26
	Silencer Length, Inches	36	36	36	36	40	44	48	52
FCL	Weight, lb.	99	111	132	149	168	188	208	234

Model	Duct Diameter, Inches	28	30	32	36	40	44	48	60
	Silencer Length, Inches	56	60	64	72	80	88	96	120
FCL	Weight, lb.	255	374	495	600	746	951	1140	1873

Table III: Aerodynamic Performance

IAC Model	L/Ft	Static Pressure Drop, i.w.g.																
		All Sizes	0.05	0.06	0.07	0.08	0.10	0.11	0.13	0.14	0.16	0.18	0.20	0.22	0.24	0.26	0.29	0.31
FCL	All Sizes																	
Silencer Face Velocity, fpm		2000	2200	2400	2600	2800	3000	3200	3400	3600	3800	4000	4200	4400	4600	4800	5000	

Table IV: Self-Noise Power Levels, dB re: 10-12 Watts

IAC Model	Octave Band	1	2	3	4	5	6	7	8
	Hz	63	125	250	500	1K	2K	4K	8K
	Silencer Face Velocity, fpm								
FCS (all sizes)	-3000	56	56	55	56	55	55	50	45
	-2000	47	47	47	47	45	45	37	29
	-1000	31	32	32	31	30	30	20	20
	1000	39	35	32	32	30	25	20	20
	2000	52	48	46	46	45	42	39	25
	3000	60	56	54	54	53	52	50	40

(+) Forward Flow / (-) Reverse Flow. Aero-acoustic performance data based on NVLAP accredited laboratory tests conducted in strict accordance with ASTM E477-99.

TAKE NOTE!

- Silencer Face Area is the cross-sectional area at the silencer entrance
- Face Velocity is the CFM of airflow divided by the Face Area (in sq. ft.)
- Pressure Drop for any velocity can be calculated from this equation:
 $PD = (Actual\ FV/Catalog\ FV)^2 \times (Catalog\ PD)$
- Self Noise values shown are for a four-square-foot face area silencer
- For each doubling of the face area add 3 dB to the self-noise values listed
- For each halving of the face area subtract 3 dB from the self-noise values listed
- Weights and measures are listed for limited number of available sizes

Low Frequency Conic-Flow® Silencers

Type: CS

Forward & Reverse Flow Ratings

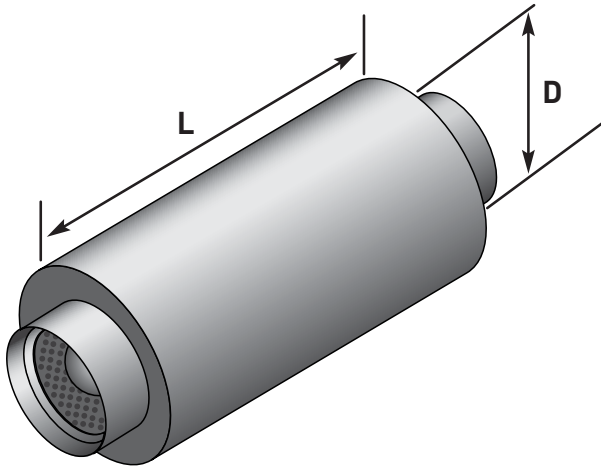

The IAC Type CS Conic-Flow Silencers have been rated with procedures certified in accordance with applicable portions of ASTM E477. All Dynamic Insertion Loss and Self-Noise Acoustic Performance Data were obtained in a NVLAP accredited Aero-Acoustic Laboratory using the duct-to-room reverberant test facility **with air flowing through the silencers.**

Designating Silencers

Model: 12 CS 36

Type: CS **Diameter:** 12" **Length:** 36"

Table I: Dynamic Insertion Loss (DIL) Ratings: Forward (+)/Reverse (-) Flow

IAC Model	Octave Band	1	2	3	4	5	6	7	8
	Hz	63	125	250	500	1K	2K	4K	8K
	Face Velocity, fpm	Dynamic Insertion Loss, dB							
12CS	-4000	9	13	22	32	36	35	31	21
	-2000	7	10	19	31	34	35	32	26
	0	6	10	18	31	34	36	33	27
	2000	4	9	16	30	34	37	33	27
	4000	3	8	14	29	33	39	33	27
24CS	-4000	10	12	20	34	43	34	20	11
	-2000	8	11	18	34	40	35	22	13
	0	7	11	18	30	38	36	23	17
	2000	5	11	18	26	36	37	24	20
	4000	4	10	17	25	34	37	27	21
36CS	-4000	11	16	22	36	38	28	19	11
	-2000	10	15	20	35	37	29	21	12
	0	10	15	20	35	37	30	22	15
	2000	9	14	19	35	36	31	23	17
	17	8	13	18	33	35	32	24	18
48CS	-4000	12	18	23	37	36	20	13	11
	-2000	11	17	21	36	35	22	14	12
	0	11	17	21	35	35	24	17	14
	2000	10	16	20	34	35	26	20	16
	4000	9	14	19	34	35	27	21	17
60CS	-4000	13	20	25	38	33	16	11	10
	-2000	12	19	24	36	32	18	12	11
	0	12	18	24	36	32	21	15	13
	2000	11	17	23	35	31	23	17	15
	4000	10	15	22	35	31	24	18	16

(+) Forward Flow / (-) Reverse Flow. Aero-acoustic performance data based on NVLAP accredited laboratory tests conducted in strict accordance with ASTM E477-99. Contact IAC if attenuation in excess of 50 dB is required.

Table II: Weights & Measures

Model	Duct Diameter, Inches	12	14	16	18	20	22	24	26
	Silencer Length, Inches	36	36	36	36	40	44	48	52
CS	Weight, lb.	74	85	105	120	135	150	165	185

Model	Duct Diameter, Inches	28	30	32	36	40	44	48	60
	Silencer Length, Inches	56	60	64	72	80	88	96	120
CS	Weight, lb.	200	305	420	530	640	820	990	1660

Table III: Aerodynamic Performance

IAC Model	L/Ft	Static Pressure Drop, i.w.g.																
		All Sizes	0.06	0.08	0.11	0.15	0.19	0.23	0.28	0.33	0.39	0.45	0.52	0.59	0.67	0.75	0.83	0.92
CS																		
Silencer Face Velocity, fpm		1000	1200	1400	1600	1800	2000	2200	2400	2600	2800	3000	3200	3400	3600	3800	4000	

Table IV: Self-Noise Power Levels, dB re: 10-12 Watts

IAC Model	Octave Band	1	2	3	4	5	6	7	8
	Hz	63	125	250	500	1K	2K	4K	8K
	Silencer Face Velocity, fpm								
CS (all sizes)	-3000	57	58	58	57	56	57	56	52
	-2000	50	49	51	49	46	47	45	39
	-1000	38	34	39	35	29	30	26	20
	1000	44	43	37	37	38	38	20	20
	2000	56	54	50	50	50	50	41	31
	3000	63	60	57	57	57	57	53	47

(+) Forward Flow / (-) Reverse Flow. Aero-acoustic performance data based on NVLAP accredited laboratory tests conducted in strict accordance with ASTM E477-99.

TAKE NOTE!

- Silencer Face Area is the cross-sectional area at the silencer entrance
- Face Velocity is the CFM of airflow divided by the Face Area (in sq. ft.)
- Pressure Drop for any velocity can be calculated from this equation:
 $PD = (\text{Actual FV}/\text{Catalog FV})^2 \times (\text{Catalog PD})$
- Self Noise values shown are for a four-square-foot face area silencer
- For each doubling of the face area add 3 dB to the self-noise values listed
- For each halving of the face area subtract 3 dB from the self-noise values listed
- Weights and measures are listed for limited number of available sizes

Low Frequency Conic-Flow® Silencers

Type: CL

Forward & Reverse Flow Ratings

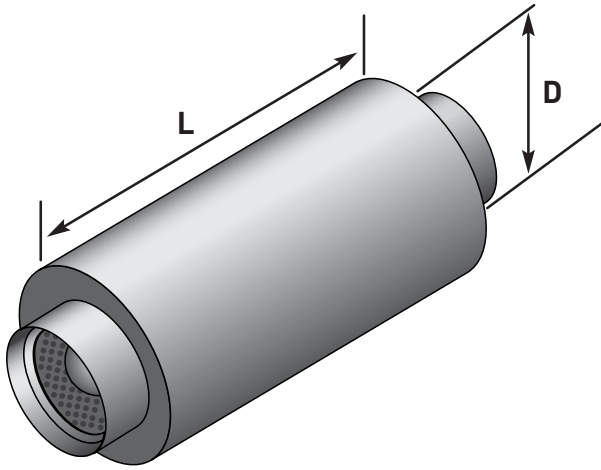

The IAC Type CL Conic-Flow Silencers have been rated with procedures certified in accordance with applicable portions of ASTM E477. All Dynamic Insertion Loss and Self-Noise Acoustic Performance Data were obtained in a NVLAP accredited Aero-Acoustic Laboratory using the duct-to-room reverberant test facility **with air flowing through the silencers.**

Designating Silencers

Model: 12 CL 36

Type: CL **Diameter:** 12" **Length:** 36"

Table I: Dynamic Insertion Loss (DIL) Ratings: Forward (+) / Reverse (-) Flow

IAC Model	Octave Band	1	2	3	4	5	6	7	8
	Hz	63	125	250	500	1K	2K	4K	8K
	Face Velocity, fpm	Dynamic Insertion Loss, dB							
12CL	-4000	7	9	17	32	35	34	22	12
	-2000	4	8	16	31	34	34	24	13
	0	4	7	15	30	34	35	24	15
	2000	4	6	13	29	34	36	24	16
	4000	4	6	13	26	33	36	24	17
24CL	-4000	7	9	16	28	35	21	17	12
	-2000	6	9	14	27	35	23	18	13
	0	6	9	14	27	35	24	20	16
	2000	5	8	13	26	34	25	22	18
	4000	4	8	13	25	34	26	22	18
36CL	-4000	9	12	18	32	30	19	16	11
	-2000	8	12	17	32	29	20	17	12
	0	8	12	17	32	29	23	19	15
	2000	7	11	16	31	29	25	20	17
	17	7	10	15	31	28	25	20	17
48CL	-4000	10	15	21	34	30	17	13	10
	-2000	10	14	20	33	30	18	14	11
	0	10	14	19	33	30	20	16	14
	2000	9	14	18	33	29	22	18	16
	4000	8	12	17	33	28	22	18	17
60CL	-4000	12	17	22	35	29	15	11	10
	-2000	11	17	21	35	29	16	12	11
	0	11	17	21	35	28	18	14	13
	2000	11	16	20	35	27	20	16	15
	4000	10	14	19	35	26	20	16	16

(+) Forward Flow / (-) Reverse Flow. Aero-acoustic performance data based on NVLAP accredited laboratory tests conducted in strict accordance with ASTM E477-99. Contact IAC if attenuation in excess of 50 dB is required.

Table II: Weights & Measures

Model	Duct Diameter, Inches	12	14	16	18	20	22	24	26
	Silencer Length, Inches	36	36	36	36	40	44	48	52
CL	Weight, lb.	74	85	105	120	135	150	165	185

Model	Duct Diameter, Inches	28	30	32	36	40	44	48	60
	Silencer Length, Inches	56	60	64	72	80	88	96	120
CS	Weight, lb.	200	305	420	530	640	820	990	1660

Table III: Aerodynamic Performance

IAC Model	L/Ft	Static Pressure Drop, i.w.g.																
		All Sizes	0.06	0.08	0.09	0.11	0.12	0.14	0.16	0.18	0.20	0.23	0.25	0.28	0.30	0.33	0.36	0.39
CL	All Sizes																	
Silencer Face Velocity, fpm		2000	2200	2400	2600	2800	3000	3200	3400	3600	3800	4000	4200	4400	4600	4800	5000	

Table IV: Self-Noise Power Levels, dB re: 10-12 Watts

IAC Model	Octave Band	1	2	3	4	5	6	7	8
	Hz	63	125	250	500	1K	2K	4K	8K
	Silencer Face Velocity, fpm								
CL (all sizes)	-3000	56	56	55	56	55	55	50	45
	-2000	47	47	47	47	45	45	37	29
	-1000	31	32	32	31	30	30	20	20
	1000	39	35	32	32	30	25	20	20
	2000	52	48	46	46	45	42	39	25
	3000	60	56	54	54	53	52	50	40

(+) Forward Flow / (-) Reverse Flow. Aero-acoustic performance data based on NVLAP accredited laboratory tests conducted in strict accordance with ASTM E477-99.

TAKE NOTE!

- Silencer Face Area is the cross-sectional area at the silencer entrance
- Face Velocity is the CFM of airflow divided by the Face Area (in sq. ft.)
- Pressure Drop for any velocity can be calculated from this equation:
 $PD = (\text{Actual FV}/\text{Catalog FV})^2 \times (\text{Catalog PD})$
- Self Noise values shown are for a four-square-foot face area silencer
- For each doubling of the face area add 3 dB to the self-noise values listed
- For each halving of the face area subtract 3 dB from the self-noise values listed
- Weights and measures are listed for limited number of available sizes

Low Frequency Conic-Flow® Silencers

Type: NS

Forward & Reverse Flow Ratings

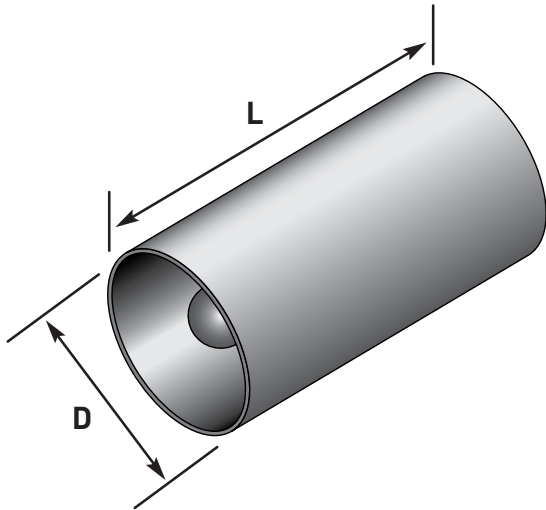

The IAC Type NS Conic-Flow Silencers have been rated with procedures certified in accordance with applicable portions of ASTM E477. All Dynamic Insertion Loss and Self-Noise Acoustic Performance Data were obtained in a NVLAP accredited Aero-Acoustic Laboratory using the duct-to-room reverberant test facility **with air flowing through the silencers.**

Designating Silencers

Model: 12 NS 36

Type: NS **Diameter:** 12" **Length:** 36"

Table I: Dynamic Insertion Loss (DIL) Ratings: Forward (+) / Reverse (-) Flow

IAC Model	Octave Band	1	2	3	4	5	6	7	8
	Hz	63	125	250	500	1K	2K	4K	8K
	Face Velocity, fpm	Dynamic Insertion Loss, dB							
12NS	-4000	3	4	9	15	24	21	13	8
	-2000	3	4	9	14	24	21	13	8
	0	3	4	9	14	22	21	14	10
	2000	3	4	9	14	19	21	14	12
	4000	3	4	9	14	17	21	14	12
24NS	-4000	4	11	16	22	25	19	11	10
	-2000	4	10	15	20	24	21	12	11
	0	4	10	15	19	24	21	12	12
	2000	4	10	14	18	23	21	12	12
	4000	4	9	13	17	23	21	12	12
36NS	-4000	6	13	17	23	23	15	10	8
	-2000	6	13	17	22	23	16	11	9
	0	6	13	17	21	23	17	11	10
	2000	6	13	17	20	22	17	11	10
	4000	6	12	16	19	22	17	11	10
48NS	-4000	7	15	19	25	22	11	9	7
	-2000	7	15	19	23	20	12	10	8
	0	7	15	19	23	20	12	10	8
	2000	7	15	19	23	20	12	10	8
	4000	7	15	19	22	20	12	10	8
60NS	-4000	10	17	21	23	19	8	7	6
	-2000	10	17	20	23	18	9	8	7
	0	10	17	20	23	18	10	9	8
	2000	10	17	20	22	17	10	9	8
	4000	9	16	19	22	17	10	10	9

(+) Forward Flow / (-) Reverse Flow. Aero-acoustic performance data based on NVLAP accredited laboratory tests conducted in strict accordance with ASTM E477-99. Contact IAC if attenuation in excess of 50 dB is required.

Table II: Weights & Measures

Model	Duct Diameter, Inches	12	14	16	18	20	22	24	26
	Silencer Length, Inches	40	46	52	58	64	72	78	84
NS	Weight, lb.	40	55	75	95	110	125	140	200

Model	Duct Diameter, Inches	28	30	32	36	40	44	48	60
	Silencer Length, Inches	90	98	104	118	130	144	156	196
NS	Weight, lb.	255	310	365	425	480	565	650	1640

Table III: Aerodynamic Performance

IAC Model	L/Ft	Static Pressure Drop, i.w.g.																
		All Sizes	0.05	0.08	0.10	0.13	0.17	0.21	0.25	0.30	0.36	0.41	0.47	0.54	0.61	0.68	0.76	0.84
NS																		
Silencer Face Velocity, fpm		1000	1200	1400	1600	1800	2000	2200	2400	2600	2800	3000	3200	3400	3600	3800	4000	

Table IV: Self-Noise Power Levels, dB re: 10-12 Watts

IAC Model	Octave Band	1	2	3	4	5	6	7	8
	Hz	63	125	250	500	1K	2K	4K	8K
	Silencer Face Velocity, fpm								
NS (all sizes)	-3000	59	56	55	57	57	59	55	50
	-2000	51	48	47	48	49	51	44	36
	-1000	37	34	33	33	35	38	26	20
	1000	44	37	33	32	35	31	20	20
	2000	56	48	45	45	47	46	38	28
	3000	63	54	52	53	54	55	50	43

(+) Forward Flow / (-) Reverse Flow. Aero-acoustic performance data based on NVLAP accredited laboratory tests conducted in strict accordance with ASTM E477-99.

TAKE NOTE!

- Silencer Face Area is the cross-sectional area at the silencer entrance
- Face Velocity is the CFM of airflow divided by the Face Area (in sq. ft.)
- Pressure Drop for any velocity can be calculated from this equation:
 $PD = (Actual\ FV/Catalog\ FV)^2 \times (Catalog\ PD)$
- Self Noise values shown are for a four-square-foot face area silencer
- For each doubling of the face area add 3 dB to the self-noise values listed
- For each halving of the face area subtract 3 dB from the self-noise values listed
- Weights and measures are listed for limited number of available sizes

Low Frequency Conic-Flow® Silencers

Type: NL

Forward & Reverse Flow Ratings

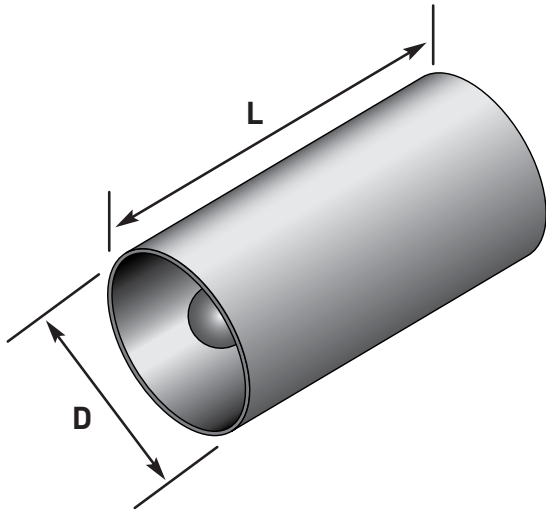

The IAC Type NL Conic-Flow Silencers have been rated with procedures certified in accordance with applicable portions of ASTM E477. All Dynamic Insertion Loss and Self-Noise Acoustic Performance Data were obtained in a NVLAP accredited Aero-Acoustic Laboratory using the duct-to-room reverberant test facility **with air flowing through the silencers.**

Designating Silencers

Model: 12 NL 36

Type: NL **Diameter:** 12" **Length:** 36"

Table I: Dynamic Insertion Loss (DIL) Ratings: Forward (+) / Reverse (-) Flow

IAC Model	Octave Band	1	2	3	4	5	6	7	8
	Hz	63	125	250	500	1K	2K	4K	8K
	Face Velocity, fpm	Dynamic Insertion Loss, dB							
12NL	-4000	2	5	10	11	17	15	9	8
	-2000	1	3	9	11	16	15	9	9
	0	1	3	9	11	16	15	10	10
	2000	1	3	9	11	15	15	10	10
	4000	1	3	8	10	14	15	10	10
24NL	-4000	5	11	14	17	18	14	10	8
	-2000	3	10	12	16	17	14	10	9
	0	3	10	12	16	17	14	11	10
	2000	3	9	11	15	16	14	11	10
	4000	3	9	11	15	16	14	11	10
36NL	-4000	6	12	16	18	16	12	9	6
	-2000	4	11	14	17	15	12	9	7
	0	4	11	14	17	15	12	10	8
	2000	4	10	13	16	15	12	10	8
	4000	4	10	13	16	15	13	11	8
48NL	-4000	8	13	18	17	14	10	8	4
	-2000	5	11	16	16	14	10	9	6
	0	5	11	16	16	14	11	9	7
	2000	5	11	15	15	14	11	9	7
	4000	5	11	15	15	14	11	10	7
60NL	-4000	10	14	18	17	11	9	6	4
	-2000	7	13	16	16	11	9	7	5
	0	7	13	16	16	11	10	7	6
	2000	7	13	15	15	11	10	7	6
	4000	7	13	15	15	11	10	8	7

(+) Forward Flow / (-) Reverse Flow. Aero-acoustic performance data based on NVLAP accredited laboratory tests conducted in strict accordance with ASTM E477-99. Contact IAC if attenuation in excess of 50 dB is required.

Table II: Weights & Measures

Model	Duct Diameter, Inches	12	14	16	18	20	22	24	26
	Silencer Length, Inches	40	46	52	58	64	72	78	84
NL	Weight, lb.	40	55	75	95	110	125	140	200

Model	Duct Diameter, Inches	28	30	32	36	40	44	48	60
	Silencer Length, Inches	90	98	104	118	130	144	156	196
NL	Weight, lb.	255	310	365	425	480	565	650	1640

Table III: Aerodynamic Performance

IAC Model	L/Ft	Static Pressure Drop, i.w.g.																
		All Sizes	0.11	0.13	0.15	0.18	0.21	0.24	0.27	0.30	0.34	0.38	0.42	0.46	0.51	0.56	0.61	0.66
NL																		
Silencer Face Velocity, fpm		2000	2200	2400	2600	2800	3000	3200	3400	3600	3800	4000	4200	4400	4600	4800	5000	

Table IV: Self-Noise Power Levels, dB re: 10-12 Watts

IAC Model	Octave Band	1	2	3	4	5	6	7	8
	Hz	63	125	250	500	1K	2K	4K	8K
	Silencer Face Velocity, fpm								
NL (all sizes)	-3000	60	59	59	58	59	58	53	43
	-2000	53	51	51	51	51	50	41	32
	-1000	40	38	38	38	38	36	20	20
	1000	39	35	32	32	30	25	21	20
	2000	52	48	46	46	45	42	39	26
	3000	59	56	54	54	53	52	50	40

(+) Forward Flow / (-) Reverse Flow. Aero-acoustic performance data based on NVLAP accredited laboratory tests conducted in strict accordance with ASTM E477-99.

TAKE NOTE!

- Silencer Face Area is the cross-sectional area at the silencer entrance
- Face Velocity is the CFM of airflow divided by the Face Area (in sq. ft.)
- Pressure Drop for any velocity can be calculated from this equation:
 $PD = (\text{Actual FV}/\text{Catalog FV})^2 \times (\text{Catalog PD})$
- Self Noise values shown are for a four-square-foot face area silencer
- For each doubling of the face area add 3 dB to the self-noise values listed
- For each halving of the face area subtract 3 dB from the self-noise values listed
- Weights and measures are listed for limited number of available sizes

D-Duct Diffuser / Silencer

Section 15000 Specifications

1.01 General

- A. Furnish and install "D-Duct" acoustic diffuser silencers of the types and sizes shown on the plans and/or listed in the schedule. Silencers shall be the product of IAC Acoustics. Any specification change must be submitted in writing and approved by the Architect/Engineer, in writing, at least 10 days prior to the bid due-date.

2.01 Materials

- A. Outer casings of tubular silencers shall be made of type #G-90 lock-former-quality galvanized steel in the following gauges based on the smallest diameter of the internal diffuser cone:

Cone Diameter, In. Up to 35.5	Metal Gauge 22	Cone Diameter, In. Up to 35.5	Metal Gauge 22
>36	18	38-60	18

- B. Diffuser silencers shall include an internal core of consistent diameter along the entire length in the direction of airflow. The core diameter shall be selected based on the adjacent hub diameter or, in the case of C-frame mounted motors, the motor frame size for the respective fan system on which the diffuser silencer is installed.
- C. The internal core shall be constructed from lock-former-quality type G-90 galvanized perforated steel in the same gauge as the internal diffuser cone. The core shall be supported by a minimum of three (3) welded radial attachment brackets installed at 120 degree angles to each other to provide uniform support.
- D. Combustion ratings for the silencer acoustic fill shall be not greater than the following when tested to ASTM E 84, NFPA Standard 255, or UL No. 723:

Flamespread Classification	20
Smoke Development Rating.....	20

3.01 Construction

- A. Four inch long, 11 gauge, sleeved end connections shall be provided as standard. When noted, rolled angle flanges shall be factory welded to the sleeve.
- B. For units where the minimum diffuser cone diameter is 36" or greater, an additional support rod shall be welded between the radial bracket and the sleeve to prevent a twist from being exerted on the internal core by the fan's air flow.
- C. All welds shall be touched-up with zinc-rich paint after fabrication by the manufacturer.
- D. The internal core and the rectangular outer jacket of the Diffuser Silencers shall be filled with glass fiber of a density sufficient to obtain the specified acoustic performance. The fill shall be packed under not less

than 5% compression to eliminate voids due to vibration or settling. The fill material shall be inert, vermin- and moisture-proof.

4.01 Acoustic Performance

- A. All silencer ratings shall be determined in a duct-to-reverberant room test facility which provides for airflow in both directions through the test silencer in accordance with ASTM Specification E477-99. The test facility shall be NVLAP accredited for the ASTM E477-99 test standard. Data from a non-accredited laboratory will not be acceptable. The test set-up and procedure shall be such that all effects due to end reflection, directivity, flanking transmission, standing waves and test chamber sound absorption are eliminated.

Acoustic ratings shall include Dynamic Insertion Loss (DIL) and Self-Noise (SN) Power Levels both for FORWARD FLOW (air and noise in same direction) and REVERSE FLOW (air and noise in opposite directions) with airflow of at least 2000 fpm entering face velocity.

5.01 Aerodynamic Performance

- A. Diffuser Silencers shall function as pressure regain devices to minimize system pressure losses at the fan. Fan selections are based on the regain performance of the Diffuser Silencer configurations specified. Any deviations in configuration which adversely affect the fan performance efficiency will not be accepted.
- B. Silencers shall not fail structurally when exposed to a differential air pressure of 8 inches water gauge inside to outside the casing.

6.01 Certification

- A. With submittals, the manufacturer shall supply certified test data on Dynamic Insertion Loss, Self-Noise Power Levels, and Aerodynamic Performance for Reverse and Forward Flow test conditions. Test data shall be for a standard product. All rating tests shall be conducted in the same facility, shall utilize the same silencer, and shall be open to inspection upon request from the Architect/Engineer.

7.01 Duct Transitions

- A. When transitions are required to adapt silencer dimensions to connecting duct work they shall be furnished by the installing contractor.

D-Duct Diffuser / Silencer

Type: DDS

Forward & Reverse Flow Ratings

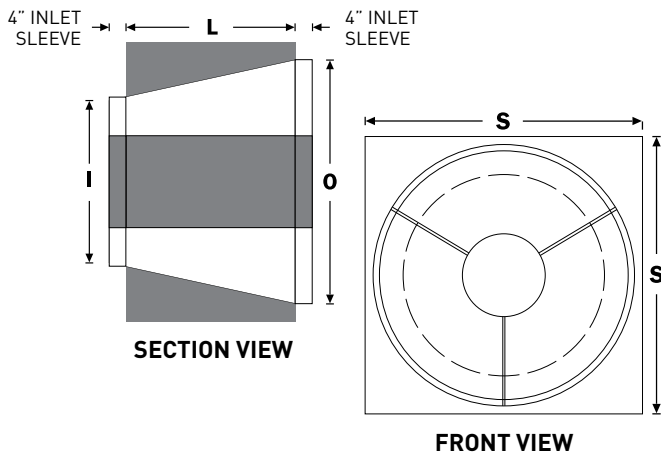

The IAC D-Duct (DDS) Diffuser/Silencer is designed for installation at the outlet of a vane axial fans. Available in sizes matched directly to manufacturer's fan sizes, it has excellent acoustic performance. At the same time it reduces system pressure drop and can be used as an effective inlet cone and silencer. The combined interior diffuser cone and exterior square jacket casing makes these units excellent when requiring aerodynamic-regain devices as well as silencers.

Overall, the IAC D-Duct Diffusers/Silencers have been completely engineered to provide noise attenuation directly at the source, improving fan aerodynamic performance for the inlet and discharge. All D-Duct Diffusers/Silencers have been rated with procedures certified in strict accordance with ASTM E477-99 in a NVLAP Accredited Acoustical Laboratory.

Physical Data

IAC Model	I Inlet Diameter (in)	O Outlet Diameter (in)	S (in)	L (in)	Weight (lb)
18-A	18.5	24	28	20.0	125
20-A	20.5	28	32	20.0	140
24-A	24.5	30	34	24.0	165
24-B	24.5	30	34	24.0	180
30-A	30.5	40	44	30.0	225
30-B	30.5	40	44	30.0	240
30-C	30.5	40	44	30.0	260
36-A	36.5	46	50	37.75	290
36-B	36.5	46	50	37.75	300
36-C	36.5	46	50	37.75	310
36-D	36.5	46	50	37.75	325
42-A	42.5	52	56	36.0	400
42-B	42.5	52	56	36.0	410
42-C	42.5	52	56	36.0	430
48-A	48.5	60	64	43.5	550
48-B	48.5	60	64	43.5	580
48-C	48.5	60	64	43.5	610
54-A	55.25	68	72	48.0	700
54-B	55.25	68	72	48.0	750
54-C	55.25	68	72	48.0	790
60-A	61.0	74	78	52.75	750
60-B	61.0	74	78	52.75	790
66-A	67.0	82	86	58.5	1190
66-B	67.0	82	86	58.5	1250
70-A	73.0	90	94	68.0	1400
70-B	73.0	90	94	68.0	1500

Dynamic Insertion Loss (DIL) Ratings (dB):

IAC Model	Octave Band	1	2	3	4	5	6	7	8
	Hz	63	125	250	500	1K	2K	4K	8K
18-A	-	-	3	13	22	27	23	17	13
20-A	-	-	2	12	20	26	22	16	12
24-A	1	4	14	20	24	20	15	12	
24-B	1	5	15	20	25	21	15	12	
30-A	1	7	15	19	21	17	14	12	
30-B	1	8	15	19	21	17	14	12	
30-C	2	8	15	19	21	18	14	12	
36-A	2	8	15	18	17	13	12	11	
36-B	2	9	15	18	17	13	11	10	
36-C	2	9	15	18	18	14	11	10	
36-D	2	9	16	18	19	14	11	10	
42-A	3	10	16	17	16	12	10	9	
42-B	3	10	16	17	16	12	11	10	
42-C	3	10	16	18	16	13	11	10	
48-A	3	11	17	18	16	12	10	10	
48-B	3	11	17	18	16	12	11	10	
48-C	3	11	18	19	17	13	12	10	
54-A	3	11	17	18	16	12	10	10	
54-B	3	11	17	18	16	12	11	10	
54-C	3	11	17	19	17	12	12	10	
60-A	4	12	18	19	14	10	10	10	
60-B	4	12	18	20	16	12	11	10	
66-A	4	12	18	19	14	10	10	10	
66-B	4	12	18	20	16	12	11	10	
70-A	4	12	17	16	12	10	10	10	
70-B	4	12	18	18	15	10	10	10	

Custom sizes are available. Please contact IAC Acoustics representative for details.

(+) Forward Flow / (-) Reverse Flow. Aero-acoustic performance data based on NVLAP accredited laboratory tests conducted in strict accordance with ASTM E477-99. Contact IAC if attenuation in excess of 50 dB is required.

Ducted Discharge

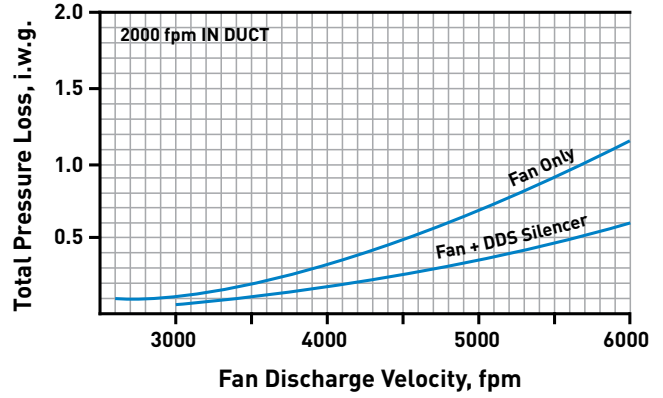
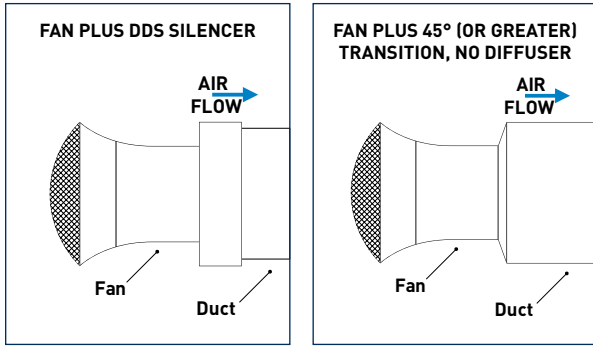

Discharge Into Low Velocity Plenums

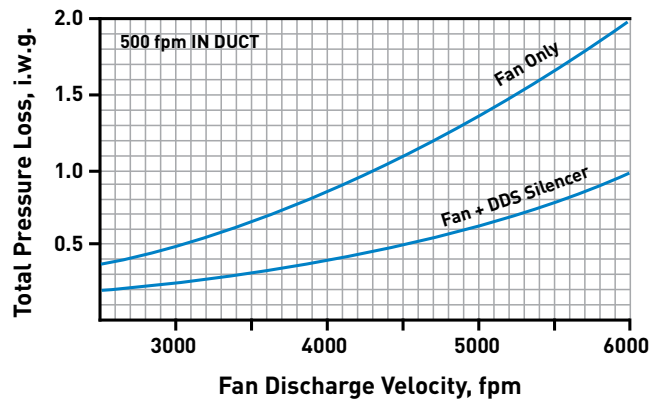
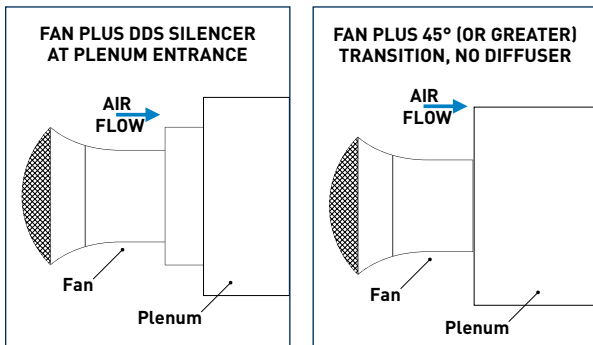

Free Discharge

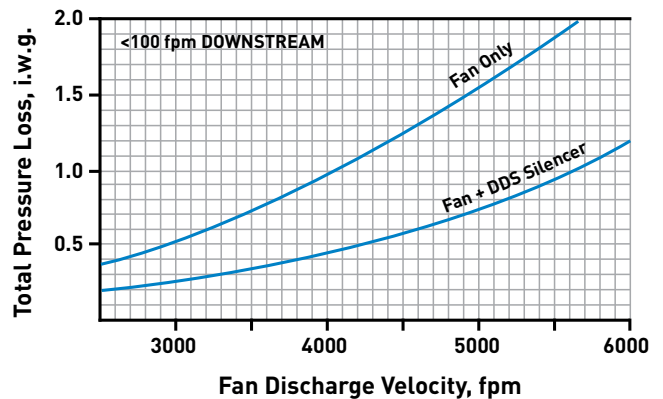
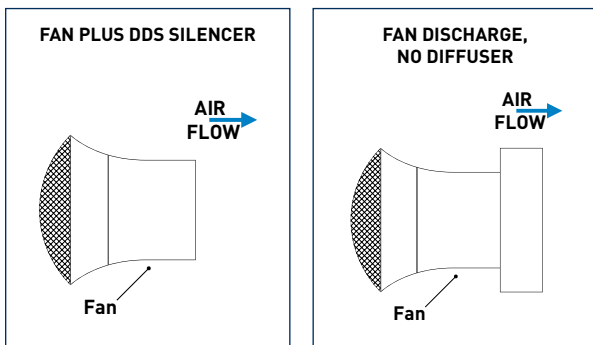

(+) Forward Flow / (-) Reverse Flow. Aero-acoustic performance data based on NVLAP accredited laboratory tests conducted in strict accordance with ASTM E477-99. Contact IAC if attenuation in excess of 50 dB is required.

Ultra Pals™ Packless Silencers

Section 15000 Specifications

1.01 General

- A. Furnish and install “Ultra-Pals” packless silencers of the types and sizes shown on the plans and/or listed in the schedule. Silencers shall be the product of IAC Acoustics. Any specification change must be submitted in writing and approved by the Architect/Engineer, in writing, at least 10 days prior to the bid due-date.

2.01 Materials

- A. Unless otherwise specified, the silencers shall be constructed of Type #G-90 lock-former-quality galvanized steel. The silencer casings shall be a minimum of #22 Gauge solid galvanized. The internal partitions shall be a minimum of #26 Gauge perforated galvanized.
- B. No sound absorptive material of any kind is to be used in the silencers. The silencers shall attenuate air/gas transmitted noise solely by virtue of controlled impedance membranes and broadly tuned resonators.
- C. Combustion ratings for the silencer acoustic fill shall be not greater than the following when tested to ASTM E 84, NFPA Standard 255, or UL No. 723:

Flamespread Classification	0
Smoke Development Rating.....	0

3.01 Construction

- A. Units shall be constructed in accordance with the ASHRAE Guide recommendations for high pressure duct work. Seams shall be lock formed and mastic filled. Rectangular casing seams shall be in the corners of the silencer shell to provide maximum unit strength and rigidity. Interior partitions shall be fabricated from single-piece, margin-perforated sheets and shall have die-formed entrance and exit shapes so as to provide the maximum aerodynamic efficiency and minimum self-noise characteristics in the sound attenuator. Blunt noses or squared off partitions will not be accepted.
- B. The interior partitions shall be attached to the casing by means of an interlocking track assembly. Tracks shall be solid galvanized steel and shall be welded to the outer casing. Attachment of the interior partitions to the tracks shall be such that a minimum of 4 thicknesses of metal exist at this location.
- C. The track assembly shall stiffen the exterior casing, provide a reinforced attachment detail for the interior partitions, and shall maintain a uniform airspace width along the length of the silencer for consistent aerodynamic and acoustic performance.
- D. Sound attenuating units shall not fail structurally when subjected to a differential air pressure of 8 inches water gauge from inside to outside the casing.

4.01 Acoustic Performance

- A. All silencer ratings shall be determined in a duct-to-reverberant room test facility which provides for airflow in both directions through the test silencer in accordance with ASTM Specification E477-99. The test facility shall be NVLAP accredited for the ASTM E477-99 test standard. Data from a non-accredited laboratory will not be acceptable. The test set-up and procedure shall be such that all effects due to end reflection, directivity, flanking transmission, standing waves and test chamber sound absorption are eliminated.

Acoustic ratings shall include Dynamic Insertion Loss (DIL) and Self-Noise (SN) Power Levels both for FORWARD FLOW (air and noise in same direction) and REVERSE FLOW (air and noise in opposite directions) with airflow of at least 2000 fpm entering face velocity. Data for rectangular and tubular type silencers shall be presented for tests conducted using silencers no smaller than the following cross-sections:

Rectangular, inch: 24 x 24, 24 x 30, or 24 x 36

5.01 Aerodynamic Performance

- A. Static pressure loss of silencers shall not exceed those listed in the silencer schedule as the airflow indicates. Airflow measurements shall be made in accordance with ASTM specification E477-99 and applicable portions of ASME, AMCA, and ADC airflow test codes. Tests shall be reported on the identical units for which acoustic data is presented.

6.01 Certification

- A. With submittals, the manufacturer shall supply certified test data on Dynamic Insertion Loss, Self-Noise Power Levels, and Aerodynamic Performance for Reverse and Forward Flow test conditions. Test data shall be for a standard product. All rating tests shall be conducted in the same facility, shall utilize the same silencer, and shall be open to inspection upon request from the Architect/Engineer.

7.01 Duct Transitions

- A. When transitions are required to adapt silencer dimensions to connecting duct work they shall be furnished by the installing contractor.

Ultra Pals™ Packless Silencers

Type: XM

Forward & Reverse Flow Ratings



- NO FIBERGLASS
- NO MINERAL WOOL
- NO FOAM
- NO FILL OF ANY KIND

The IAC Type XM Packless Silencers provide excellent low frequency Dynamic Insertion Loss characteristics making them suitable for virtually any HVAC application.

The complete absence of fill, combined with ease of cleaning and draining, makes Ultra-Pals Silencers well suited for chemical plants, refineries and facilities handling gasoline, grease, solvents or other hazardous materials.

The broad band Dynamic Insertion Loss characteristics of these packless silencers makes them an excellent choice for pharmaceutical, cosmetic, food & dairy plants, hospital operating rooms, electronic manufacturing and other clean room applications where particulate matter or fiber erosion from conventional fill materials could contaminate the air/gas streams.

Designating Silencers

Model: 5XM 24 x 18

Type: XM **Length:** 5' **Width:** 24" **Height:** 18"

Table I: Dynamic Insertion Loss (DIL) Ratings: Forward (+) / Reverse (-) Flow

IAC Model	Octave Band	1	2	3	4	5	6	7	8
	Hz	63	125	250	500	1K	2K	4K	8K
	Face Velocity, fpm	Dynamic Insertion Loss, dB							
3XM	-1500	6	8	12	18	22	13	10	7
	-1000	6	6	10	17	20	12	9	8
	0	4	4	7	15	17	11	10	9
	1000	6	4	10	17	20	12	10	9
	1500	5	5	11	17	23	13	10	8
6XM	-1500	10	15	23	33	30	16	11	10
	-1000	9	12	17	30	25	14	12	11
	0	5	7	11	25	22	14	13	12
	1000	7	9	15	27	25	14	14	12
	1500	7	11	17	30	29	16	14	13
9XM	-1500	12	22	32	39	38	21	16	13
	-1000	10	19	26	36	31	19	18	16
	0	7	12	15	31	27	19	18	17
	1000	8	16	22	35	29	20	19	18
	1500	7	17	25	38	34	22	18	17

(+) Forward Flow / (-) Reverse Flow. Aero-acoustic performance data based on NVLAP accredited laboratory tests conducted in strict accordance with ASTM E477-99. Contact IAC if attenuation in excess of 50 dB is required.

Table II: Weights & Measures

Nominal Length	W/In H/In	12	12	12	12	12	12	24	24	24	24	24	24
		12	18	24	30	36	48	12	18	24	30	36	48
3'	Wt/lb.	28	37	45	54	63	72	55	67	82	98	113	130
6'		56	74	90	108	126	144	110	134	164	196	226	258
9'		84	111	135	162	189	216	156	201	246	294	339	380

Table III: Aerodynamic Performance

IAC Model	L/Ft	Static Pressure Drop, i.w.g.															
		XM	3'	0.02	0.03	0.04	0.06	0.07	0.09	0.11	0.13	0.15	0.17	0.20	0.23	0.26	0.29
6'	0.03		0.04	0.06	0.08	0.10	0.12	0.15	0.17	0.20	0.24	0.27	0.31	0.35	0.39	0.43	0.48
9'	0.04		0.05	0.07	0.10	0.12	0.15	0.18	0.22	0.26	0.30	0.34	0.39	0.44	0.49	0.55	0.60
Silencer Face Velocity, fpm		250	300	350	400	450	500	550	600	650	700	750	800	850	900	950	1000

Table IV: Self-Noise Power Levels, dB re: 10-12 Watts

IAC Model	Octave Band	1	2	3	4	5	6	7	8
	Hz	63	125	250	500	1K	2K	4K	8K
	Silencer Face Velocity, fpm								
3XM	-3000	64	62	64	66	65	64	66	62
	-2000	53	50	54	56	56	59	58	51
	-1000	42	40	43	45	47	46	37	27
	1000	47	34	36	35	40	37	27	20
6XM 9XM	-2000	64	61	58	59	60	64	67	64
	-1000	56	52	52	52	55	61	60	50
	1000	58	54	49	46	52	60	60	50
	2000	66	67	65	61	58	63	69	67

(+) Forward Flow / (-) Reverse Flow. Aero-acoustic performance data based on NVLAP accredited laboratory tests conducted in strict accordance with ASTM E477-99.

TAKE NOTE!

- Silencer Face Area is the cross-sectional area at the silencer entrance
- Face Velocity is the CFM of airflow divided by the Face Area (in sq. ft.)
- Pressure Drop for any velocity can be calculated from this equation:
 $PD = (Actual\ FV/Catalog\ FV)^2 \times (Catalog\ PD)$
- Self Noise values shown are for a four-square-foot face area silencer
- For each doubling of the face area add 3 dB to the self-noise values listed
- For each halving of the face area subtract 3 dB from the self-noise values listed
- Weights and measures are listed for limited number of available sizes

Ultra Pals™ Packless Silencers

Type: XL

Forward & Reverse Flow Ratings



- NO FIBERGLASS
- NO MINERAL WOOL
- NO FOAM
- NO FILL OF ANY KIND

The IAC Type XL Packless Silencers provide excellent low frequency Dynamic Insertion Loss characteristics making them suitable for virtually any HVAC application.

The complete absence of fill, combined with ease of cleaning and draining, makes Ultra-Pals Silencers well suited for chemical plants, refineries and facilities handling gasoline, grease, solvents or other hazardous materials.

The broad band Dynamic Insertion Loss characteristics of these packless silencers makes them an excellent choice for pharmaceutical, cosmetic, food & dairy plants, hospital operating rooms, electronic manufacturing and other clean room applications where particulate matter or fiber erosion from conventional fill materials could contaminate the air/gas streams.

Designating Silencers

Model: 5XL 24 x 18

Type: XL **Length:** 5' **Width:** 24" **Height:** 18"

Table I: Dynamic Insertion Loss (DIL) Ratings: Forward (+) / Reverse (-) Flow

IAC Model	Octave Band	1	2	3	4	5	6	7	8
	Hz	63	125	250	500	1K	2K	4K	8K
	Face Velocity, fpm	Dynamic Insertion Loss, dB							
3XL	-1500	9	12	18	21	13	11	9	7
	-1000	8	10	16	20	12	11	9	7
	0	8	7	15	17	11	11	9	8
	1000	7	8	17	21	13	11	9	8
	1500	7	9	18	21	14	13	9	9
6XL	-1500	12	20	25	30	19	16	13	10
	-1000	12	18	23	27	18	15	13	10
	0	8	11	19	23	16	14	13	11
	1000	11	14	23	28	19	15	13	12
	1500	10	15	24	30	21	17	14	12
9XL	-1500	19	28	32	38	27	21	16	11
	-1000	16	25	29	34	24	19	16	12
	0	11	15	22	27	20	18	16	15
	1000	13	20	29	33	25	20	16	16
	1500	13	21	29	35	26	23	18	15

(+) Forward Flow / (-) Reverse Flow. Aero-acoustic performance data based on NVLAP accredited laboratory tests conducted in strict accordance with ASTM E477-99. Contact IAC if attenuation in excess of 50 dB is required.

Table II: Weights & Measures

Nominal Length	W/In H/In	12	12	12	12	12	12	24	24	24	24	24	24
		12	18	24	30	36	48	12	18	24	30	36	48
3'	Wt/lb.	25	33	40	47	55	63	42	52	63	73	84	95
6'		50	66	80	94	110	125	85	104	126	146	168	188
9'		75	99	120	141	165	188	126	156	189	219	252	284

Table III: Aerodynamic Performance

IAC Model	L/Ft	Static Pressure Drop, i.w.g.															
		XL	3'	0.03	0.04	0.06	0.08	0.10	0.12	0.15	0.17	0.20	0.24	0.27	0.31	0.35	0.39
6'	0.04		0.05	0.07	0.10	0.12	0.15	0.18	0.22	0.26	0.30	0.34	0.39	0.44	0.49	0.55	0.60
9'	0.04		0.06	0.09	0.11	0.14	0.18	0.22	0.26	0.30	0.35	0.40	0.46	0.51	0.58	0.64	0.71
Silencer Face Velocity, fpm		250	300	350	400	450	500	550	600	650	700	750	800	850	900	950	1000

Table IV: Self-Noise Power Levels, dB re: 10-12 Watts

IAC Model	Octave Band	1	2	3	4	5	6	7	8
	Hz	63	125	250	500	1K	2K	4K	8K
	Silencer Face Velocity, fpm								
3XL	-1500	54	52	56	58	59	64	65	58
	-1000	42	44	49	51	55	59	55	45
	1000	46	42	44	46	52	57	55	52
	1500	54	54	57	54	54	62	65	59
6XL 9XL	-2000	64	61	58	59	60	64	67	64
	-1000	56	52	52	52	55	61	60	50
	1000	58	54	49	46	52	60	60	50
	2000	66	67	65	61	58	63	69	67

(+) Forward Flow / (-) Reverse Flow. Aero-acoustic performance data based on NVLAP accredited laboratory tests conducted in strict accordance with ASTM E477-99.

TAKE NOTE!

- Silencer Face Area is the cross-sectional area at the silencer entrance
- Face Velocity is the CFM of airflow divided by the Face Area (in sq. ft.)
- Pressure Drop for any velocity can be calculated from this equation:
 $PD = (Actual\ FV/Catalog\ FV)^2 \times (Catalog\ PD)$
- Self Noise values shown are for a four-square-foot face area silencer
- For each doubling of the face area add 3 dB to the self-noise values listed
- For each halving of the face area subtract 3 dB from the self-noise values listed
- Weights and measures are listed for limited number of available sizes

Ultra Pals™ Packless Silencers

Type: KL

Forward & Reverse Flow Ratings



- NO FIBERGLASS
- NO MINERAL WOOL
- NO FOAM
- NO FILL OF ANY KIND

The IAC Type KL Packless Silencers combine excellent low frequency Dynamic Insertion Loss characteristics with a lower air flow pressure drop making them suit for higher velocity HVAC applications.

The complete absence of fill, combined with ease of cleaning and draining, makes Ultra-Pals Silencers well suited for chemical plants, refineries and facilities handling gasoline, grease, solvents or other hazardous materials.

The broad band Dynamic Insertion Loss characteristics of these packless silencers makes them an excellent choice for pharmaceutical, cosmetic, food & dairy plants, hospital operating rooms, electronic manufacturing and other clean room applications where particulate matter or fiber erosion from conventional fill materials could contaminate the air/gas streams.

Designating Silencers

Model: 5KL 24 x 18

Type: KL **Length:** 5' **Width:** 24" **Height:** 18"

Table I: Dynamic Insertion Loss (DIL) Ratings: Forward (+) / Reverse (-) Flow

IAC Model	Octave Band	1	2	3	4	5	6	7	8
	Hz	63	125	250	500	1K	2K	4K	8K
	Face Velocity, fpm	Dynamic Insertion Loss, dB							
3KL	-2000	7	9	16	14	11	8	7	6
	-1000	4	6	14	12	8	7	7	6
	0	5	4	11	9	7	7	7	5
	1000	4	5	13	11	7	7	6	4
	2000	5	7	15	13	10	8	7	5
6KL	-2000	9	10	22	16	11	9	8	9
	-1000	7	8	18	14	10	9	8	9
	0	6	6	16	14	9	9	9	8
	1000	6	7	18	14	10	9	8	8
	2000	8	8	21	16	12	10	8	7
9KL	-2000	13	15	28	19	15	10	10	9
	-1000	11	11	24	17	13	10	10	9
	0	9	9	20	17	12	11	10	9
	1000	10	9	24	17	13	11	10	8
	2000	11	11	28	19	15	12	10	8

(+) Forward Flow / (-) Reverse Flow. Aero-acoustic performance data based on NVLAP accredited laboratory tests conducted in strict accordance with ASTM E477-99. Contact IAC if attenuation in excess of 50 dB is required.

Table II: Weights & Measures

Nominal Length	W/In H/In	15	15	15	15	15	15	15	30	30	30	30	30	30
3'	Wt/lb.	30	37	44	51	59	67	51	61	71	82	92	102	48
6'		60	74	88	102	118	132	101	122	142	164	184	204	
9'		90	111	132	153	177	198	152	183	213	246	276	305	

Table III: Aerodynamic Performance

IAC Model	L/Ft	Static Pressure Drop, i.w.g.															
		KL	3'	0.03	0.05	0.06	0.08	0.11	0.13	0.16	0.19	0.22	0.25	0.29	0.33	0.38	0.42
6'	0.04		0.05	0.07	0.10	0.12	0.15	0.18	0.22	0.25	0.29	0.34	0.38	0.43	0.49	0.54	0.60
9'	0.05		0.06	0.09	0.12	0.15	0.18	0.22	0.26	0.30	0.35	0.41	0.46	0.52	0.58	0.65	0.72
Silencer Face Velocity, fpm		500	600	700	800	900	1000	1100	1200	1300	1400	1500	1600	1700	1800	1900	2000

Table IV: Self-Noise Power Levels, dB re: 10-12 Watts

IAC Model	Octave Band	1	2	3	4	5	6	7	8
	Hz	63	125	250	500	1K	2K	4K	8K
	Silencer Face Velocity, fpm								
3KL	-2000	49	51	54	58	59	63	63	54
	-1000	38	38	42	47	51	48	41	35
	1000	36	36	38	43	49	46	38	35
	2000	53	49	50	51	54	62	63	54
6KL	-2000	54	55	55	57	58	62	62	54
	-1000	44	50	44	51	52	49	40	24
	1000	52	43	40	44	50	50	42	25
	2000	58	58	54	54	55	64	66	59

(+) Forward Flow / (-) Reverse Flow. Aero-acoustic performance data based on NVLAP accredited laboratory tests conducted in strict accordance with ASTM E477-99.

TAKE NOTE!

- Silencer Face Area is the cross-sectional area at the silencer entrance
- Face Velocity is the CFM of airflow divided by the Face Area (in sq. ft.)
- Pressure Drop for any velocity can be calculated from this equation:
 $PD = (Actual\ FV/Catalog\ FV)^2 \times (Catalog\ PD)$
- Self Noise values shown are for a four-square-foot face area silencer
- For each doubling of the face area add 3 dB to the self-noise values listed
- For each halving of the face area subtract 3 dB from the self-noise values listed
- Weights and measures are listed for limited number of available sizes

Ultra Pals™ Packless Silencers

Type: KM

Forward & Reverse Flow Ratings



The IAC Type KM Packless Silencers combine excellent low frequency Dynamic Insertion Loss characteristics with a lower air flow pressure drop making them suit for higher velocity HVAC applications.

The complete absence of fill, combined with ease of cleaning and draining, makes Ultra-Pals Silencers well suited for chemical plants, refineries and facilities handling gasoline, grease, solvents or other hazardous materials.

The broad band Dynamic Insertion Loss characteristics of these packless silencers makes them an excellent choice for pharmaceutical, cosmetic, food & dairy plants, hospital operating rooms, electronic manufacturing and other clean room applications where particulate matter or fiber erosion from conventional fill materials could contaminate the air/gas streams.

- NO FIBERGLASS
- NO MINERAL WOOL
- NO FOAM
- NO FILL OF ANY KIND

Designating Silencers

Model: 5KM 24 x 18

Type: KM **Length:** 5' **Width:** 24" **Height:** 18"

Table I: Dynamic Insertion Loss (DIL) Ratings: Forward (+) / Reverse (-) Flow

IAC Model	Octave Band	1	2	3	4	5	6	7	8
	Hz	63	125	250	500	1K	2K	4K	8K
	Face Velocity, fpm	Dynamic Insertion Loss, dB							
3KM	-2000	4	5	10	16	14	10	7	7
	-1000	3	3	7	13	12	8	7	7
	0	3	2	5	12	11	7	7	6
	1000	3	3	6	13	11	7	6	5
	2000	3	4	7	14	14	8	6	5
6KM	-2000	9	9	17	24	21	9	9	8
	-1000	8	5	12	19	16	8	9	8
	0	5	4	9	18	15	9	9	8
	1000	6	4	10	19	16	9	9	7
	2000	7	5	13	23	20	10	9	8
9KM	-2000	12	12	23	33	25	12	12	10
	-1000	10	8	16	27	20	11	13	10
	0	9	6	12	25	20	12	12	11
	1000	9	7	15	26	21	12	12	10
	2000	8	9	18	31	25	14	12	10

(+) Forward Flow / (-) Reverse Flow. Aero-acoustic performance data based on NVLAP accredited laboratory tests conducted in strict accordance with ASTM E477-99. Contact IAC if attenuation in excess of 50 dB is required.

Table II: Weights & Measures

Nominal Length	W/In H/In	15	15	15	15	15	15	30	30	30	30	30	30
		15	18	30	30	36	48	15	18	30	30	36	48
3'	Wt/lb.	32	41	50	58	67	76	53	76	91	106	121	126
6'		64	82	100	116	134	152	124	152	182	212	242	272
9'		96	123	150	174	201	226	185	228	273	318	363	408

Table III: Aerodynamic Performance

IAC Model	L/Ft	Static Pressure Drop, i.w.g.															
		KM	3'	0.03	0.04	0.05	0.07	0.09	0.11	0.13	0.15	0.18	0.21	0.24	0.27	0.31	0.35
6'	0.03		0.04	0.06	0.08	0.10	0.12	0.15	0.18	0.21	0.24	0.28	0.32	0.36	0.40	0.45	0.50
9'	0.04		0.05	0.07	0.09	0.12	0.14	0.17	0.20	0.24	0.28	0.32	0.36	0.41	0.46	0.51	0.57
Silencer Face Velocity, fpm		500	600	700	800	900	1000	1100	1200	1300	1400	1500	1600	1700	1800	1900	2000

Table IV: Self-Noise Power Levels, dB re: 10-12 Watts

IAC Model	Octave Band	1	2	3	4	5	6	7	8
	Hz	63	125	250	500	1K	2K	4K	8K
	Silencer Face Velocity, fpm								
3KM	-2000	49	51	54	58	59	63	63	54
	-1000	38	38	42	47	51	48	41	35
	1000	36	36	38	43	49	46	38	35
	2000	53	49	50	51	54	62	63	54
6KM 9KM	-2000	54	55	55	57	58	62	62	54
	-1000	44	50	44	51	52	49	40	24
	1000	52	43	40	44	50	50	42	25
	2000	58	58	54	53	55	64	66	59

(+) Forward Flow / (-) Reverse Flow. Aero-acoustic performance data based on NVLAP accredited laboratory tests conducted in strict accordance with ASTM E477-99.

TAKE NOTE!

- Silencer Face Area is the cross-sectional area at the silencer entrance
- Face Velocity is the CFM of airflow divided by the Face Area (in sq. ft.)
- Pressure Drop for any velocity can be calculated from this equation:
 $PD = (Actual\ FV/Catalog\ FV)^2 \times (Catalog\ PD)$
- Self Noise values shown are for a four-square-foot face area silencer
- For each doubling of the face area add 3 dB to the self-noise values listed
- For each halving of the face area subtract 3 dB from the self-noise values listed
- Weights and measures are listed for limited number of available sizes

Tubular Ultra Pals™ Packless Silencers

Type: TXS / TXL

Forward & Reverse Flow Ratings

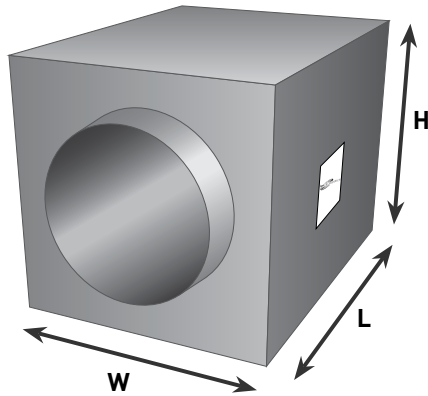

- NO FIBERGLASS
- NO MINERAL WOOL
- NO FOAM
- NO FILL OF ANY KIND

The IAC Type TXS/TXL Tubular Packless Silencers have been designed primarily for use in fume hood applications. The complete absence of fill, combined with ease of cleaning and draining, makes these silencers ideally suited for chemical plants, refineries and facilities handling gasoline, grease, solvents or other hazardous materials.

The broad band Dynamic Insertion Loss characteristics of these silencers makes them an excellent choice for pharmaceutical, cosmetic, food & dairy plants, hospital operating rooms, electronic manufacturing and other clean room applications where particulate matter or fiber erosion from conventional fill materials could contaminate the air/gas streams.

Designating Silencers

Model: 12TXS 36

Type: TXS **Diameter:** 12" **Length:** 36"

Table I: Dynamic Insertion Loss (DIL) Ratings: Forward (+) / Reverse (-) Flow

IAC Model	Octave Band	1	2	3	4	5	6	7	8
	Hz	63	125	250	500	1K	2K	4K	8K
	Face Velocity, fpm	Dynamic Insertion Loss, dB							
8TXS36	-2000	15	20	26	17	12	12	12	7
	-1000	15	18	26	16	11	12	12	8
	0	15	18	26	16	10	12	12	8
	1000	15	18	26	16	10	12	11	7
	2000	15	19	26	18	12	11	11	6
8TXL36	-2000	13	16	25	16	9	7	6	4
	-1000	13	16	25	15	8	7	6	3
	0	13	15	25	14	8	7	6	3
	1000	13	15	25	14	8	7	6	4
	2000	12	15	25	15	8	7	6	4
12TXS36	-2000	11	13	23	25	18	12	13	9
	-1000	9	11	19	22	14	11	13	9
	0	7	8	17	20	13	10	11	8
	1000	7	8	17	20	13	10	11	8
	2000	7	8	18	22	15	10	11	8
12TXL36	-2000	5	8	16	16	7	6	5	4
	-1000	5	8	16	16	7	6	5	4
	0	4	8	16	16	7	7	5	3
	1000	4	8	16	16	7	7	5	3
	2000	5	8	16	17	7	7	5	3

(+) Forward Flow / (-) Reverse Flow. Aero-acoustic performance data based on NVLAP accredited laboratory tests conducted in strict accordance with ASTM E477-99. Contact IAC if attenuation in excess of 50 dB is required.

Table II: Aerodynamic Performance

IAC Model	Diameter, In.	Width, In.	Height, In.	Length, In.	Weight, lb.	Static Pressure Drop, i.w.g.							
						0.15	0.20	0.26	0.33	0.41	0.50	0.59	0.69
TXS	8	21	21	36	30	0.15	0.20	0.26	0.33	0.41	0.50	0.59	0.69
TXL	8	21	21	36	30	0.04	0.05	0.07	0.08	0.10	0.12	0.15	0.17
TXS	12	21	21	36	35	0.14	0.19	0.25	0.32	0.39	0.47	0.56	0.66
TXL	12	21	21	36	35	0.04	0.05	0.06	0.08	0.10	0.12	0.14	0.17
Silencer Face Velocity, fpm						1500	1750	2000	2250	2500	2750	3000	3250

Table IV: Self-Noise Power Levels, dB re: 10-12 Watts

IAC Model	Octave Band	1	2	3	4	5	6	7	8
	Hz	63	125	250	500	1K	2K	4K	8K
	Silencer Face Velocity, fpm								
TXS	-2000	54	47	49	47	51	50	46	38
	-1000	20	35	37	37	37	32	20	20
	1000	20	34	35	35	35	28	20	20
	2000	54	47	45	45	49	50	45	34
TXL	-2000	20	33	37	39	36	31	20	20
	-1000	20	20	25	25	23	20	20	20
	1000	20	22	28	28	25	20	20	20
	2000	20	35	42	41	35	29	20	20

(+) Forward Flow / (-) Reverse Flow. Aero-acoustic performance data based on NVLAP accredited laboratory tests conducted in strict accordance with ASTM E477-99.

TAKE NOTE!

- Silencer Face Area is the cross-sectional area at the silencer entrance
- Face Velocity is the CFM of airflow divided by the Face Area (in sq. ft.)
- Pressure Drop for any velocity can be calculated from this equation:
 $PD = (Actual\ FV/Catalog\ FV)^2 \times (Catalog\ PD)$
- Self Noise values shown are for a four-square-foot face area silencer
- For each doubling of the face area add 3 dB to the self-noise values listed
- For each halving of the face area subtract 3 dB from the self-noise values listed
- Weights and measures are listed for limited number of available sizes

Tubular Elbow Ultra Pals™ Packless Silencers

Type: TXLB

Forward & Reverse Flow Ratings

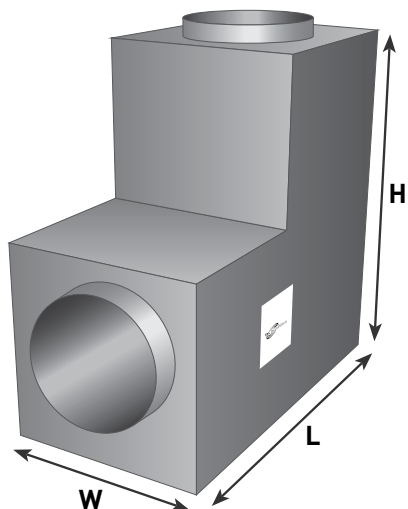

- NO FIBERGLASS
- NO MINERAL WOOL
- NO FOAM
- NO FILL OF ANY KIND

The IAC Type TXLB Tubular Elbow Packless Silencers have been designed primarily for use in fume hood applications. The complete absence of fill combined with ease of cleaning and draining makes the Type TXLB ideally suited for chemical plants, refineries and facilities handling gasoline, grease, solvents or other hazardous materials. The elbow configuration makes for a compact arrangement suitable for low head-room or tight space installations.

The broad band Dynamic Insertion Loss characteristics of these silencers makes them an excellent choice for pharmaceutical, cosmetic, food & dairy plants, hospital operating rooms, electronic manufacturing and other clean room applications where particulate matter or fiber erosion from conventional fill materials could contaminate the air/gas streams.

Designating Silencers

Model: 12TLB 36

Type: TXLB **Diameter:** 12" **Length:** 36"

Table I: Dynamic Insertion Loss (DIL) Ratings: Forward (+) / Reverse (-) Flow

IAC Model	Octave Band	1	2	3	4	5	6	7	8
	Hz	63	125	250	500	1K	2K	4K	8K
	Face Velocity, fpm	Dynamic Insertion Loss, dB							
8TXLB36	-2000	10	14	26	20	17	14	12	9
	-1000	10	14	26	18	14	14	11	9
	0	9	13	25	17	14	13	10	8
	1000	10	13	25	17	14	13	11	8
	2000	10	13	24	19	16	14	12	8
12TXLB36	-2000	7	8	21	20	15	11	9	4
	-1000	7	8	20	19	13	10	8	4
	0	5	6	18	17	11	9	7	3
	1000	5	6	18	17	11	9	7	3
	2000	6	7	18	19	14	10	8	3

(+) Forward Flow / (-) Reverse Flow. Aero-acoustic performance data based on NVLAP accredited laboratory tests conducted in strict accordance with ASTM E477-99. Contact IAC if attenuation in excess of 50 dB is required.

Table II: Aerodynamic Performance

IAC Model	Diameter, In.	Width, In.	Height, In.	Length, In.	Weight, lb.	Static Pressure Drop, i.w.g.							
						0.05	0.09	0.14	0.20	0.28	0.36	0.46	0.56
TXLB	8	21	21	36	110	0.05	0.09	0.14	0.20	0.28	0.36	0.46	0.56
	12	21	21	36	120	0.05	0.09	0.14	0.20	0.28	0.36	0.46	0.56
Silencer Face Velocity, fpm						750	1000	1250	1500	1750	2000	2250	2500

Table IV: Self-Noise Power Levels, dB re: 10-12 Watts

IAC Model	Octave Band	1	2	3	4	5	6	7	8
	Hz	63	125	250	500	1K	2K	4K	8K
	Silencer Face Velocity, fpm								
8TXLB36	-2000	50	43	40	40	41	43	40	31
	-1000	42	32	32	26	23	20	20	20
	1000	42	29	27	32	30	23	21	20
	2000	51	43	41	43	45	49	45	33
12TXLB36	-2000	58	44	42	44	46	48	47	38
	-1000	50	40	34	35	31	27	20	20
	1000	52	38	34	34	35	27	20	20
	2000	62	47	43	45	49	52	49	38

(+) Forward Flow / (-) Reverse Flow. Aero-acoustic performance data based on NVLAP accredited laboratory tests conducted in strict accordance with ASTM E477-99.

TAKE NOTE!

- Silencer Face Area is the cross-sectional area at the silencer entrance
- Face Velocity is the CFM of airflow divided by the Face Area (in sq. ft.)
- Pressure Drop for any velocity can be calculated from this equation:
 $PD = (Actual\ FV/Catalog\ FV)^2 \times (Catalog\ PD)$
- Self Noise values shown are for a four-square-foot face area silencer
- For each doubling of the face area add 3 dB to the self-noise values listed
- For each halving of the face area subtract 3 dB from the self-noise values listed
- Weights and measures are listed for limited number of available sizes

Quiet-Elbow™ Silencers

Section 15000 Specifications

1.01 General

- A.** Furnish and install “Quiet-Duct Elbow” style silencers of the types and sizes shown on the plans and/or listed in the schedule. Silencers shall be the product of IAC Acoustics. Any specification change must be submitted in writing and approved by the Architect/Engineer, in writing, at least 10 days prior to the bid due-date.

2.01 Materials

- A.** Outer casing of the silencer shall be made of minimum 18 gauge type #G-90 lock-former-quality galvanized steel. Interior partitions for the silencer shall be not less than 22 gauge type #G-90 galvanized perforated steel.
- B.** Filler material shall be of inorganic glass fiber of a proper density to obtain the specified acoustic performance and be packed under not less than 5% compression to eliminate voids due to vibration and settling. Material shall be inert, vermin- and moisture-proof.
- C.** Combustion ratings for the silencer acoustic fill shall be not greater than the following when tested per ASTM E 84, NFPA Standard 255, or UL No. 723:

Flamespread Classification	20
Smoke Development Rating.....	20

3.01 Construction

- A.** Units shall be constructed in accordance with the ASHRAE Guide recommendations for high pressure duct work. Casing seams shall be formed, welded, and mastic sealed. Interior acoustic baffles shall be perforated sheets with solid evase design entrance/exit shapes to provide maximum aerodynamic efficiency and minimum self-noise. Blunt shapes will not be accepted.
- B.** Interior partitions shall be welded to the casing and shall be of radius design so as to provide a uniform elbow airway in the silencer.
- C.** Sound attenuating units shall not fail structurally when subjected to a differential air pressure of 8 inches water gauge from inside to outside the casing.

4.01 Acoustic Performance

- A.** Silencer ratings shall have been determined from data taken in a duct-to-reverberant room test facility which provides for airflow through the test silencer in accordance with ASTM Specification E477-99. The test facility shall be NVLAP accredited for the ASTM E477-99 test standard. Data from a non-accredited laboratory will not be acceptable. The test set-up and procedure shall be such that all effects due to end reflection, directivity, flanking transmission, standing waves and test chamber sound absorption are eliminated.
- B.** Acoustic ratings shall include Dynamic Insertion Loss (DIL) and Self-Noise (SN) Power Levels both for FORWARD FLOW (air and noise in same direction) and REVERSE FLOW (air and noise in opposite directions) with airflow of at least 2000 fpm entering face velocity. Data for radius elbow silencers shall be presented for tests conducted using silencers no smaller than the following sizes:

Rectangular, inches: 24 x 24, 24 x 30, or 24 x 36

5.01 Aerodynamic Performance

- A.** Static pressure loss of the silencer shall not exceed that listed in the schedule at the airflow indicated. Airflow measurements shall be made in accordance with ASTM specification E477-99 and applicable portions of ASME, AMCA, and ADC airflow test codes.

6.01 Certification

- A.** With submittals, the manufacturer shall supply data on Dynamic Insertion Loss, Self-Noise Power Levels, and Aerodynamic Performance for Forward and Reverse Flow test conditions. All rating tests shall be conducted in the same facility, shall have utilized the same silencer, and the facility shall be open to inspection upon request from the Architect/Engineer.

Quiet-Elbow™ Silencers

Type: ELBM-LFS

Forward & Reverse Flow Ratings

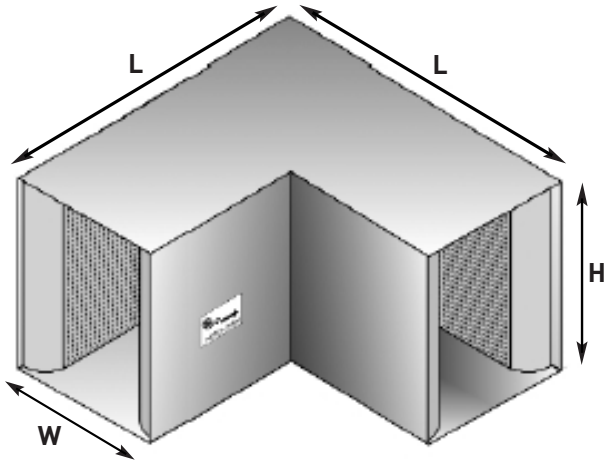

IAC Type ELBM Modular Elbows are designed to fit where shorter type of duct runs do not allow for standard type rectangular silencers. ELBM elbows also add the benefit of improved mid-range frequency performance while keeping the pressure drop minimal. ELBM's can come as standard with fiberglass infill with the same characteristics of our Quiet-Duct Commercial Series; they can also come as 100% Environmental friendly having the same characteristics of our Quiet-Duct Ultra/Green Series and they can also come with our "Hospital Grade" type characteristics, as with our Quiet-Duct Clean-Flow Series.

Designating Silencers

Model: 5ELBM 24 x 18

Type: ELBM **Length:** 5' **Width:** 24" **Height:** 18"

Pressure Loss for ELBM silencers is 0.2" at 1000 fpm

Table I: Dynamic Insertion Loss (DIL) Ratings: Forward (+) / Reverse (-) Flow

IAC Model	Octave Band	1	2	3	4	5	6	7	8
	Hz	63	125	250	500	1K	2K	4K	8K
	Face Velocity, fpm	Dynamic Insertion Loss, dB							
3ELBM-LFS	-2000	10	13	24	33	31	27	22	19
	-1000	10	13	24	33	31	27	22	19
	0	10	13	24	33	31	27	22	19
	1000	10	13	24	33	31	27	22	19
	2000	10	13	24	33	31	27	22	19
5ELBM-LFS	-2000	13	19	32	42	44	32	27	21
	-1000	13	19	32	42	44	32	27	21
	0	13	19	32	42	44	32	27	21
	1000	13	19	32	42	44	32	27	21
	2000	13	19	32	42	44	32	27	21
7ELBM-LFS	-2000	13	24	41	54	54	42	34	24
	-1000	13	24	41	54	54	42	34	24
	0	13	24	41	54	54	42	34	24
	1000	13	24	41	54	54	42	34	24
	2000	13	24	41	54	54	42	34	24
10ELBM-LFS	-2000	21	29	48	59	58	51	41	28
	-1000	21	29	48	59	58	51	41	28
	0	21	29	48	59	58	51	41	28
	1000	21	29	48	59	58	51	41	28
	2000	21	29	48	59	58	51	41	28

(+) Forward Flow / (-) Reverse Flow. Aero-acoustic performance data based on NVLAP accredited laboratory tests conducted in strict accordance with ASTM E477-99. Contact IAC if attenuation in excess of 50 dB is required.

Table II: Weights & Measures

IAC Model	W/In	12	12	12	12	12	12	12	24	24	24	24	24	24	24
	H/In	12	18	24	30	36	42	48	12	18	24	30	36	42	48
3ELBM-LFS	Wt/lb.	48	63	83	103	123	148	178	83	98	118	138	158	188	218
5ELBM-LFS		83	103	138	163	198	235	273	138	158	188	218	248	293	338
7ELBM-LFS		125	153	202	237	286	337.8	391	202	230	272	314	356	419	482
10ELBM-LFS		188	228	298	348	418	492	568	298	338	398	458	518	608	698

IAC Model	W/In	36	36	36	36	36	36	36	48	48	48	48	48	48	48
	H/In	12	18	24	30	36	42	48	12	18	24	30	36	42	48
3ELBM-LFS	Wt/lb.	N/A	N/A	N/A	N/A	N/A	N/A	N/A	N/A	N/A	N/A	N/A	N/A	N/A	N/A
5ELBM-LFS		133	203	243	278	318	393	443	184	218	298	378	458	538	618
7ELBM-LFS		195	293	349	398	454	559	629	266.4	314	426	538	650	762	874
10ELBM-LFS		288	428	508	578	658	808	908	390	458	618	778	938	1098	1258

Table III: Aerodynamic Performance

IAC Model	L/Ft	Static Pressure Drop, i.w.g.															
		0.04	0.05	0.07	0.09	0.11	0.14	0.17	0.20	0.24	0.28	0.32	0.36	0.41	0.46	0.51	0.57
ELBM-LFS	3'	0.04	0.05	0.07	0.09	0.11	0.14	0.17	0.20	0.24	0.28	0.32	0.36	0.41	0.46	0.51	0.57
	5'	0.04	0.05	0.07	0.09	0.11	0.14	0.17	0.20	0.24	0.28	0.32	0.36	0.41	0.46	0.51	0.57
	7'	0.04	0.05	0.07	0.09	0.11	0.14	0.17	0.20	0.24	0.28	0.32	0.36	0.41	0.46	0.51	0.57
	10'	0.04	0.05	0.07	0.09	0.11	0.14	0.17	0.20	0.24	0.28	0.32	0.36	0.41	0.46	0.51	0.57
Silencer Face Velocity, fpm		250	300	350	400	450	500	550	600	650	700	750	800	850	900	950	1000

Table IV: Self-Noise Power Levels, dB re: 10-12 Watts

IAC Model	Octave Band	1	2	3	4	5	6	7	8
	Hz	63	125	250	500	1K	2K	4K	8K
	Silencer Face Velocity, fpm								
ELBM-LFS	-2000	64	67	68	71	69	68	68	66
	-1000	58	61	60	62	53	57	55	59
	0	59	65	62	63	61	65	60	58
	1000	59	69	63	63	68	72	65	56
	2000	69	76	74	77	76	75	74	65

(+) Forward Flow / (-) Reverse Flow. Aero-acoustic performance data based on NVLAP accredited laboratory tests conducted in strict accordance with ASTM E477-99.

TAKE NOTE!

- Silencer Face Area is the cross-sectional area at the silencer entrance
- Face Velocity is the CFM of airflow divided by the Face Area (in sq. ft.)
- Pressure Drop for any velocity can be calculated from this equation:
 $PD = (Actual\ FV/Catalog\ FV)^2 \times (Catalog\ PD)$
- Self Noise values shown are for a four-square-foot face area silencer
- For each doubling of the face area add 3 dB to the self-noise values listed
- For each halving of the face area subtract 3 dB from the self-noise values listed
- Weights and measures are listed for limited number of available sizes

Quiet-Elbow™ Silencers

Type: ELBM-LFM

Forward & Reverse Flow Ratings

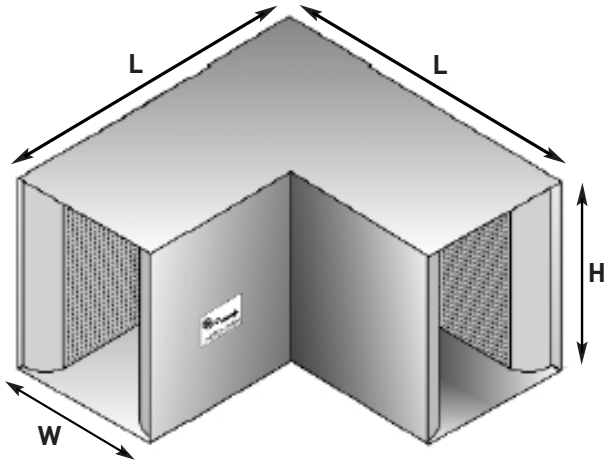

IAC Type ELBM Modular Elbows are designed to fit where shorter type of duct runs do not allow for standard type rectangular silencers. ELBM elbows also add the benefit of improved mid-range frequency performance while keeping the pressure drop minimal. ELBM's can come as standard with fiberglass infill with the same characteristics of our Quiet-Duct Commercial Series; they can also come as 100% Environmental friendly having the same characteristics of our Quiet-Duct Ultra/Green Series and they can also come with our "Hospital Grade" type characteristics, as with our Quiet-Duct Clean-Flow Series.

Designating Silencers

Model: 5ELBM 24 x 18

Type: ELBM **Length:** 5' **Width:** 24" **Height:** 18"

Pressure Loss for ELBM silencers is 0.2" at 1000 fpm

Table I: Dynamic Insertion Loss (DIL) Ratings: Forward (+) / Reverse (-) Flow

IAC Model	Octave Band	1	2	3	4	5	6	7	8
	Hz	63	125	250	500	1K	2K	4K	8K
	Face Velocity, fpm	Dynamic Insertion Loss, dB							
3ELBM-LFM	-2000	5	7	17	25	22	17	15	15
	-1000	5	7	17	25	22	17	15	15
	0	5	7	17	25	22	17	15	15
	1000	5	7	17	25	22	17	15	15
	2000	5	7	17	25	22	17	15	15
5ELBM-LFM	-2000	10	13	25	35	33	22	18	18
	-1000	10	13	25	35	33	22	18	18
	0	10	13	25	35	33	22	18	18
	1000	10	13	25	35	33	22	18	18
	2000	10	13	25	35	33	22	18	18
7ELBM-LFM	-2000	15	16	32	47	43	27	21	19
	-1000	15	16	32	47	43	27	21	19
	0	15	16	32	47	43	27	21	19
	1000	15	16	32	47	43	27	21	19
	2000	15	16	32	47	43	27	21	19
10ELBM-LFM	-2000	17	23	42	57	55	33	26	21
	-1000	17	23	42	57	55	33	26	21
	0	17	23	42	57	55	33	26	21
	1000	17	23	42	57	55	33	26	21
	2000	17	23	42	57	55	33	26	21

(+) Forward Flow / (-) Reverse Flow. Aero-acoustic performance data based on NVLAP accredited laboratory tests conducted in strict accordance with ASTM E477-99. Contact IAC if attenuation in excess of 50 dB is required.

Table II: Weights & Measures

IAC Model	W/In H/In	12	12	12	12	12	12	12	24	24	24	24	24	24	24
3ELBM-LFM	Wt/Lb.	59	74	94	114	134	159	189	94	109	129	149	169	199	229
5ELBM-LFM		94	114	149	174	209	246	284	149	169	199	229	259	304	349
7ELBM-LFM		136	164	213	248	297	348.8	402	213	241	283	325	367	430	493
10ELBM-LFM		199	239	309	359	429	503	579	309	349	409	469	529	619	709

IAC Model	W/In H/In	36	36	36	36	36	36	36	48	48	48	48	48	48	48
3ELBM-LFM	Wt/Lb.	N/A	N/A	N/A	N/A	N/A	N/A	N/A	N/A	N/A	N/A	N/A	N/A	N/A	N/A
5ELBM-LFM		144	214	254	289	329	404	454	195	229	309	389	469	549	629
7ELBM-LFM		206	304	360	409	465	570	640	277.4	325	437	549	661	773	885
10ELBM-LFM		299	439	519	589	669	819	919	401	469	629	789	949	1109	1269

Table III: Aerodynamic Performance

IAC Model	L/Ft	Static Pressure Drop, i.w.g.															
		ELBM-LFM	3'	0.01	0.02	0.02	0.03	0.04	0.05	0.06	0.07	0.08	0.09	0.11	0.12	0.14	0.15
5'	0.01		0.02	0.02	0.03	0.04	0.05	0.06	0.07	0.08	0.09	0.11	0.12	0.14	0.15	0.17	0.19
7'	0.01		0.02	0.02	0.03	0.04	0.05	0.06	0.07	0.08	0.09	0.11	0.12	0.14	0.15	0.17	0.19
10'	0.01		0.02	0.02	0.03	0.04	0.05	0.06	0.07	0.08	0.09	0.11	0.12	0.14	0.15	0.17	0.19
Silencer Face Velocity, fpm		250	300	350	400	450	500	550	600	650	700	750	800	850	900	950	1000

Table IV: Self-Noise Power Levels, dB re: 10-12 Watts

IAC Model	Octave Band	1	2	3	4	5	6	7	8
	Hz	63	125	250	500	1K	2K	4K	8K
	Silencer Face Velocity, fpm								
ELBM-LFM	-2000	59	63	64	66	63	65	61	54
	-1000	55	59	58	64	55	54	48	49
	0	58	60	56	60	59	57	48	44
	1000	60	61	54	55	63	60	48	39
	2000	55	64	67	67	66	70	65	54

(+) Forward Flow / (-) Reverse Flow. Aero-acoustic performance data based on NVLAP accredited laboratory tests conducted in strict accordance with ASTM E477-99.

TAKE NOTE!

- Silencer Face Area is the cross-sectional area at the silencer entrance
- Face Velocity is the CFM of airflow divided by the Face Area (in sq. ft.)
- Pressure Drop for any velocity can be calculated from this equation:
 $PD = (Actual\ FV/Catalog\ FV)^2 \times (Catalog\ PD)$
- Self Noise values shown are for a four-square-foot face area silencer
- For each doubling of the face area add 3 dB to the self-noise values listed
- For each halving of the face area subtract 3 dB from the self-noise values listed
- Weights and measures are listed for limited number of available sizes

Quiet-Elbow™ Silencers

Type: ELBM-LFL

Forward & Reverse Flow Ratings

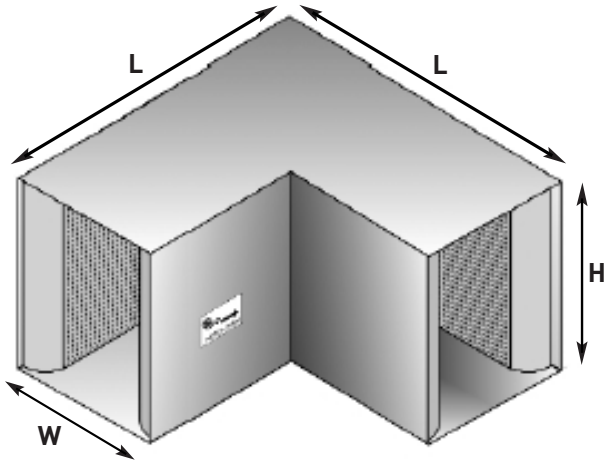

IAC Type ELBM Modular Elbows are designed to fit where shorter type of duct runs do not allow for standard type rectangular silencers. ELBM elbows also add the benefit of improved mid-range frequency performance while keeping the pressure drop minimal. ELBM's can come as standard with fiberglass infill with the same characteristics of our Quiet-Duct Commercial Series; they can also come as 100% Environmental friendly having the same characteristics of our Quiet-Duct Ultra/Green Series and they can also come with our "Hospital Grade" type characteristics, as with our Quiet-Duct Clean-Flow Series.

Designating Silencers

Model: 5ELBM 24 x 18

Type: ELBM **Length:** 5' **Width:** 24" **Height:** 18"

Pressure Loss for ELBM silencers is 0.2" at 1000 fpm

Table I: Dynamic Insertion Loss (DIL) Ratings: Forward (+) / Reverse (-) Flow

IAC Model	Octave Band	1	2	3	4	5	6	7	8
	Hz	63	125	250	500	1K	2K	4K	8K
	Face Velocity, fpm	Dynamic Insertion Loss, dB							
3ELBM-LFL	-2000	4	7	14	22	20	15	14	13
	-1000	4	7	14	22	20	15	14	13
	0	4	7	14	22	20	15	14	13
	1000	4	7	14	22	20	15	14	13
	2000	4	7	14	22	20	15	14	13
5ELBM-LFL	-2000	6	10	18	31	30	19	16	16
	-1000	6	10	18	31	30	19	16	16
	0	6	10	18	31	30	19	16	16
	1000	6	10	18	31	30	19	16	16
	2000	6	10	18	31	30	19	16	16
7ELBM-LFL	-2000	8	13	24	43	36	22	18	18
	-1000	8	13	24	43	36	22	18	18
	0	8	13	24	43	36	22	18	18
	1000	8	13	24	43	36	22	18	18
	2000	8	13	24	43	36	22	18	18
10ELBM-LFL	-2000	12	18	32	51	46	26	20	20
	-1000	12	18	32	51	46	26	20	20
	0	12	18	32	51	46	26	20	20
	1000	12	18	32	51	46	26	20	20
	2000	12	18	32	51	46	26	20	20

(+) Forward Flow / (-) Reverse Flow. Aero-acoustic performance data based on NVLAP accredited laboratory tests conducted in strict accordance with ASTM E477-99. Contact IAC if attenuation in excess of 50 dB is required.

Table II: Weights & Measures

IAC Model	W/In	12	12	12	12	12	12	12	24	24	24	24	24	24	24
	H/In	12	18	24	30	36	42	48	12	18	24	30	36	42	48
3ELBM-LFL	Wt/lb.	59	74	94	114	134	159	189	94	109	129	149	169	199	229
5ELBM-LFL		94	114	149	174	209	246	284	149	169	199	229	259	304	349
7ELBM-LFL		136	164	213	248	297	348.8	402	213	241	283	325	367	430	493
10ELBM-LFL		199	239	309	359	429	503	579	309	349	409	469	529	619	709

IAC Model	W/In	36	36	36	36	36	36	36	48	48	48	48	48	48	48
	H/In	12	18	24	30	36	42	48	12	18	24	30	36	42	48
3ELBM-LFL	Wt/lb.	N/A	N/A	N/A	N/A	N/A	N/A	N/A	N/A	N/A	N/A	N/A	N/A	N/A	N/A
5ELBM-LFL		144	214	254	289	329	404	454	195	229	309	389	469	549	629
7ELBM-LFL		206	304	360	409	465	570	640	277.4	325	437	549	661	773	885
10ELBM-LFL		299	439	519	589	669	819	919	401	469	629	789	949	1109	1269

Table III: Aerodynamic Performance

IAC Model	L/Ft	Static Pressure Drop, i.w.g.															
		0.00	0.01	0.01	0.01	0.02	0.02	0.02	0.03	0.03	0.04	0.04	0.05	0.05	0.06	0.07	0.07
ELBM-LFL	3'	0.00	0.01	0.01	0.01	0.02	0.02	0.02	0.03	0.03	0.04	0.04	0.05	0.05	0.06	0.07	0.07
	5'	0.00	0.01	0.01	0.01	0.02	0.02	0.02	0.03	0.03	0.04	0.04	0.05	0.05	0.06	0.07	0.07
	7'	0.00	0.01	0.01	0.01	0.02	0.02	0.02	0.03	0.03	0.04	0.04	0.05	0.05	0.06	0.07	0.07
	10'	0.00	0.01	0.01	0.01	0.02	0.02	0.02	0.03	0.03	0.04	0.04	0.05	0.05	0.06	0.07	0.07
Silencer Face Velocity, fpm		250	300	350	400	450	500	550	600	650	700	750	800	850	900	950	1000

Table IV: Self-Noise Power Levels, dB re: 10-12 Watts

IAC Model	Octave Band	1	2	3	4	5	6	7	8
	Hz	63	125	250	500	1K	2K	4K	8K
	Silencer Face Velocity, fpm								
ELBM-LFL	-2000	52	58	58	59	57	60	52	45
	-1000	44	49	49	54	48	53	39	42
	0	45	50	50	50	53	58	42	41
	1000	45	51	50	45	57	62	45	39
	2000	48	54	58	55	64	65	56	42

(+) Forward Flow / (-) Reverse Flow. Aero-acoustic performance data based on NVLAP accredited laboratory tests conducted in strict accordance with ASTM E477-99.

TAKE NOTE!

- Silencer Face Area is the cross-sectional area at the silencer entrance
- Face Velocity is the CFM of airflow divided by the Face Area (in sq. ft.)
- Pressure Drop for any velocity can be calculated from this equation:
 $PD = (Actual\ FV/Catalog\ FV)^2 \times (Catalog\ PD)$
- Self Noise values shown are for a four-square-foot face area silencer
- For each doubling of the face area add 3 dB to the self-noise values listed
- For each halving of the face area subtract 3 dB from the self-noise values listed
- Weights and measures are listed for limited number of available sizes

Quiet-Elbow™ Silencers

Type: ELBM-MS

Forward & Reverse Flow Ratings

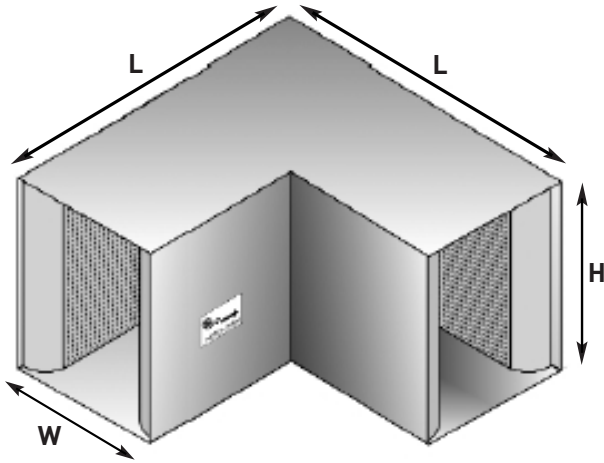

IAC Type ELBM Modular Elbows are designed to fit where shorter type of duct runs do not allow for standard type rectangular silencers. ELBM elbows also add the benefit of improved mid-range frequency performance while keeping the pressure drop minimal. ELBM's can come as standard with fiberglass infill with the same characteristics of our Quiet-Duct Commercial Series; they can also come as 100% Environmental friendly having the same characteristics of our Quiet-Duct Ultra/Green Series and they can also come with our "Hospital Grade" type characteristics, as with our Quiet-Duct Clean-Flow Series.

Designating Silencers

Model: 5ELBM 24 x 18

Type: ELBM **Length:** 5' **Width:** 24" **Height:** 18"

Pressure Loss for ELBM silencers is 0.2" at 1000 fpm

Table I: Dynamic Insertion Loss (DIL) Ratings: Forward (+) / Reverse (-) Flow

IAC Model	Octave Band	1	2	3	4	5	6	7	8
	Hz	63	125	250	500	1K	2K	4K	8K
	Face Velocity, fpm	Dynamic Insertion Loss, dB							
3ELBM-MS	-2000	4	7	13	25	28	28	23	16
	-1000	4	7	13	25	28	28	23	16
	0	4	7	13	25	28	28	23	16
	1000	4	7	13	25	28	28	23	16
	2000	4	7	13	25	28	28	23	16
5ELBM-MS	-2000	6	10	19	36	47	39	28	19
	-1000	6	10	19	36	47	39	28	19
	0	6	10	19	36	47	39	28	19
	1000	6	10	19	36	47	39	28	19
	2000	6	10	19	36	47	39	28	19
7ELBM-MS	-2000	10	14	25	42	53	49	36	23
	-1000	10	14	25	42	53	49	36	23
	0	10	14	25	42	53	49	36	23
	1000	10	14	25	42	53	49	36	23
	2000	10	14	25	42	53	49	36	23
10ELBM-MS	-2000	12	20	35	48	56	57	48	27
	-1000	12	20	35	48	56	57	48	27
	0	12	20	35	48	56	57	48	27
	1000	12	20	35	48	56	57	48	27
	2000	12	20	35	48	56	57	48	27

(+) Forward Flow / (-) Reverse Flow. Aero-acoustic performance data based on NVLAP accredited laboratory tests conducted in strict accordance with ASTM E477-99. Contact IAC if attenuation in excess of 50 dB is required.

Table II: Weights & Measures

IAC Model	W/In H/In	12	12	12	12	12	12	12	24	24	24	24	24	24	24
		12	18	24	30	36	42	48	12	18	24	30	36	42	48
3ELBM-MS	Wt/Lb.	70	85	105	125	145	170	200	105	120	140	160	180	210	240
5ELBM-MS		105	125	160	185	220	257	295	160	180	210	240	270	315	360
7ELBM-MS		147	175	224	259	308	359.8	413	224	252	294	336	378	441	504
10ELBM-MS		210	250	320	370	440	514	590	320	360	420	480	540	630	720

IAC Model	W/In H/In	36	36	36	36	36	36	36	48	48	48	48	48	48	48
		12	18	24	30	36	42	48	12	18	24	30	36	42	48
3ELBM-MS	Wt/Lb.	N/A	N/A	N/A	N/A	N/A	N/A	N/A	N/A	N/A	N/A	N/A	N/A	N/A	N/A
5ELBM-MS		155	225	265	300	340	415	465	206	240	320	400	480	560	640
7ELBM-MS		217	315	371	420	476	581	651	288.4	336	448	560	672	784	896
10ELBM-MS		310	450	530	600	680	830	930	412	480	640	800	960	1120	1280

Table III: Aerodynamic Performance

IAC Model	L/Ft	Static Pressure Drop, i.w.g.															
		0.01	0.01	0.01	0.02	0.02	0.02	0.03	0.04	0.04	0.05	0.06	0.06	0.07	0.08	0.09	0.10
ELBM-MS	3'	0.01	0.01	0.01	0.02	0.02	0.02	0.03	0.04	0.04	0.05	0.06	0.06	0.07	0.08	0.09	0.10
	5'	0.01	0.01	0.01	0.02	0.02	0.02	0.03	0.04	0.04	0.05	0.06	0.06	0.07	0.08	0.09	0.10
	7'	0.01	0.01	0.01	0.02	0.02	0.02	0.03	0.04	0.04	0.05	0.06	0.06	0.07	0.08	0.09	0.10
	10'	0.01	0.01	0.01	0.02	0.02	0.02	0.03	0.04	0.04	0.05	0.06	0.06	0.07	0.08	0.09	0.10
Silencer Face Velocity, fpm		250	300	350	400	450	500	550	600	650	700	750	800	850	900	950	1000

Table IV: Self-Noise Power Levels, dB re: 10-12 Watts

IAC Model	Octave Band	1	2	3	4	5	6	7	8
	Hz	63	125	250	500	1K	2K	4K	8K
	Silencer Face Velocity, fpm								
ELBM-MS	-2000	66	69	66	66	64	65	61	52
	-1000	59	64	60	60	58	59	54	45
	0	58	62	57	57	56	57	52	43
	1000	57	59	54	54	54	55	50	40
	2000	64	66	61	61	62	62	57	48

(+) Forward Flow / (-) Reverse Flow. Aero-acoustic performance data based on NVLAP accredited laboratory tests conducted in strict accordance with ASTM E477-99.

TAKE NOTE!

- Silencer Face Area is the cross-sectional area at the silencer entrance
- Face Velocity is the CFM of airflow divided by the Face Area (in sq. ft.)
- Pressure Drop for any velocity can be calculated from this equation:
 $PD = (Actual\ FV/Catalog\ FV)^2 \times (Catalog\ PD)$
- Self Noise values shown are for a four-square-foot face area silencer
- For each doubling of the face area add 3 dB to the self-noise values listed
- For each halving of the face area subtract 3 dB from the self-noise values listed
- Weights and measures are listed for limited number of available sizes

Quiet-Elbow™ Silencers

Type: ELBM-ML

Forward & Reverse Flow Ratings

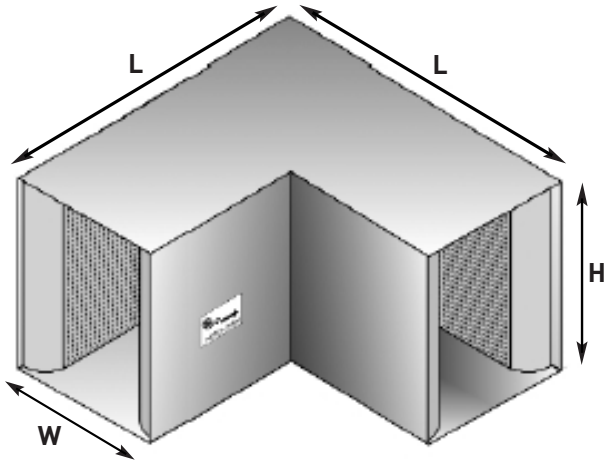

IAC Type ELBM Modular Elbows are designed to fit where shorter type of duct runs do not allow for standard type rectangular silencers. ELBM elbows also add the benefit of improved mid-range frequency performance while keeping the pressure drop minimal. ELBM's can come as standard with fiberglass infill with the same characteristics of our Quiet-Duct Commercial Series; they can also come as 100% Environmental friendly having the same characteristics of our Quiet-Duct Ultra/Green Series and they can also come with our "Hospital Grade" type characteristics, as with our Quiet-Duct Clean-Flow Series.

Designating Silencers

Model: 5ELBM 24 x 18

Type: ELBM **Length:** 5' **Width:** 24" **Height:** 18"

Pressure Loss for ELBM silencers is 0.2" at 1000 fpm

Table I: Dynamic Insertion Loss (DIL) Ratings: Forward (+) / Reverse (-) Flow

IAC Model	Octave Band	1	2	3	4	5	6	7	8
	Hz	63	125	250	500	1K	2K	4K	8K
	Face Velocity, fpm	Dynamic Insertion Loss, dB							
3ELBM-ML	-2000	2	5	11	23	22	18	15	13
	-1000	2	5	11	23	22	18	15	13
	0	2	5	11	23	22	18	15	13
	1000	2	5	11	23	22	18	15	13
	2000	2	5	11	23	22	18	15	13
5ELBM-ML	-2000	3	8	16	34	35	26	19	15
	-1000	3	8	16	34	35	26	19	15
	0	3	8	16	34	35	26	19	15
	1000	3	8	16	34	35	26	19	15
	2000	3	8	16	34	35	26	19	15
7ELBM-ML	-2000	4	12	21	42	43	33	23	17
	-1000	4	12	21	42	43	33	23	17
	0	4	12	21	42	43	33	23	17
	1000	4	12	21	42	43	33	23	17
	2000	4	12	21	42	43	33	23	17
10ELBM-ML	-2000	8	18	28	48	52	45	28	17
	-1000	8	18	28	48	52	45	28	17
	0	8	18	28	48	52	45	28	17
	1000	8	18	28	48	52	45	28	17
	2000	8	18	28	48	52	45	28	17

(+) Forward Flow / (-) Reverse Flow. Aero-acoustic performance data based on NVLAP accredited laboratory tests conducted in strict accordance with ASTM E477-99. Contact IAC if attenuation in excess of 50 dB is required.

Table II: Weights & Measures

IAC Model	W/In	12	12	12	12	12	12	12	24	24	24	24	24	24	24
	H/In	12	18	24	30	36	42	48	12	18	24	30	36	42	48
3ELBM-ML	Wt/lb.	70	85	105	125	145	170	200	105	120	140	160	180	210	240
5ELBM-ML		105	125	160	185	220	257	295	160	180	210	240	270	315	360
7ELBM-ML		147	175	224	259	308	359.8	413	224	252	294	336	378	441	504
10ELBM-ML		210	250	320	370	440	514	590	320	360	420	480	540	630	720

IAC Model	W/In	36	36	36	36	36	36	36	48	48	48	48	48	48	48
	H/In	12	18	24	30	36	42	48	12	18	24	30	36	42	48
3ELBM-ML	Wt/lb.	N/A	N/A	N/A	N/A	N/A	N/A	N/A	N/A	N/A	N/A	N/A	N/A	N/A	N/A
5ELBM-ML		155	225	265	300	340	415	465	206	240	320	400	480	560	640
7ELBM-ML		217	315	371	420	476	581	651	288.4	336	448	560	672	784	896
10ELBM-ML		310	450	530	600	680	830	930	412	480	640	800	960	1120	1280

Table III: Aerodynamic Performance

IAC Model	L/Ft	Static Pressure Drop, i.w.g.																
		0.00	0.00	0.01	0.01	0.01	0.01	0.01	0.01	0.02	0.02	0.02	0.03	0.03	0.04	0.04	0.04	0.05
ELBM-ML	3'	0.00	0.00	0.01	0.01	0.01	0.01	0.01	0.01	0.02	0.02	0.02	0.03	0.03	0.04	0.04	0.04	0.05
	5'	0.00	0.00	0.01	0.01	0.01	0.01	0.01	0.01	0.02	0.02	0.02	0.03	0.03	0.04	0.04	0.04	0.05
	7'	0.00	0.00	0.01	0.01	0.01	0.01	0.01	0.01	0.02	0.02	0.02	0.03	0.03	0.04	0.04	0.04	0.05
	10'	0.00	0.00	0.01	0.01	0.01	0.01	0.01	0.01	0.02	0.02	0.02	0.03	0.03	0.04	0.04	0.04	0.05
Silencer Face Velocity, fpm		250	300	350	400	450	500	550	600	650	700	750	800	850	900	950	1000	

Table IV: Self-Noise Power Levels, dB re: 10-12 Watts

IAC Model	Octave Band	1	2	3	4	5	6	7	8
	Hz	63	125	250	500	1K	2K	4K	8K
	Silencer Face Velocity, fpm								
ELBM-ML	-2000	62	66	62	63	63	64	55	47
	-1000	55	61	56	57	57	58	48	42
	0	54	62	52	52	53	55	49	41
	1000	52	62	48	47	49	51	49	39
	2000	59	64	55	54	57	59	55	43

(+) Forward Flow / (-) Reverse Flow. Aero-acoustic performance data based on NVLAP accredited laboratory tests conducted in strict accordance with ASTM E477-99.

TAKE NOTE!

- Silencer Face Area is the cross-sectional area at the silencer entrance
- Face Velocity is the CFM of airflow divided by the Face Area (in sq. ft.)
- Pressure Drop for any velocity can be calculated from this equation:
 $PD = (Actual\ FV/Catalog\ FV)^2 \times (Catalog\ PD)$
- Self Noise values shown are for a four-square-foot face area silencer
- For each doubling of the face area add 3 dB to the self-noise values listed
- For each halving of the face area subtract 3 dB from the self-noise values listed
- Weights and measures are listed for limited number of available sizes

Quiet-Elbow™ Silencers

Type: ELBM-S

Forward & Reverse Flow Ratings

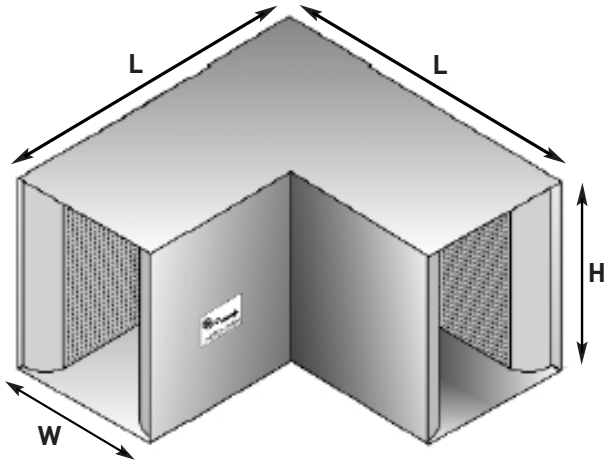

IAC Type ELBM Modular Elbows are designed to fit where shorter type of duct runs do not allow for standard type rectangular silencers. ELBM elbows also add the benefit of improved mid-range frequency performance while keeping the pressure drop minimal. ELBM's can come as standard with fiberglass infill with the same characteristics of our Quiet-Duct Commercial Series; they can also come as 100% Environmental friendly having the same characteristics of our Quiet-Duct Ultra/Green Series and they can also come with our "Hospital Grade" type characteristics, as with our Quiet-Duct Clean-Flow Series.

Designating Silencers

Model: 5ELBM 24 x 18

Type: ELBM **Length:** 5' **Width:** 24" **Height:** 18"

Pressure Loss for ELBM silencers is 0.2" at 1000 fpm

Table I: Dynamic Insertion Loss (DIL) Ratings: Forward (+) / Reverse (-) Flow

IAC Model	Octave Band	1	2	3	4	5	6	7	8
	Hz	63	125	250	500	1K	2K	4K	8K
	Face Velocity, fpm	Dynamic Insertion Loss, dB							
3ELBM-S	-2000	7	12	17	34	40	40	33	22
	-1000	7	12	17	34	40	40	33	22
	0	7	12	17	34	40	40	33	22
	1000	7	12	17	34	40	40	33	22
	2000	7	12	17	34	40	40	33	22
5ELBM-S	-2000	8	18	25	46	50	51	46	31
	-1000	8	18	25	46	50	51	46	31
	0	8	18	25	46	50	51	46	31
	1000	8	18	25	46	50	51	46	31
	2000	8	18	25	46	50	51	46	31
7ELBM-S	-2000	10	20	36	51	55	53	50	39
	-1000	10	20	36	51	55	53	50	39
	0	10	20	36	51	55	53	50	39
	1000	10	20	36	51	55	53	50	39
	2000	10	20	36	51	55	53	50	39
10ELBM-S	-2000	13	23	43	58	60	58	56	50
	-1000	13	23	43	58	60	58	56	50
	0	13	23	43	58	60	58	56	50
	1000	13	23	43	58	60	58	56	50
	2000	13	23	43	58	60	58	56	50

(+) Forward Flow / (-) Reverse Flow. Aero-acoustic performance data based on NVLAP accredited laboratory tests conducted in strict accordance with ASTM E477-99. Contact IAC if attenuation in excess of 50 dB is required.

Table II: Weights & Measures

IAC Model	W/In H/In	12	12	12	12	12	12	12	24	24	24	24	24	24	24
3ELBM-S	Wt/lb.	82	97	117	137	157	182	212	117	132	152	172	192	222	252
5ELBM-S		117	137	172	197	232	269	307	172	192	222	252	282	327	372
7ELBM-S		159	187	236	271	320	371.8	425	236	264	306	348	390	453	516
10ELBM-S		222	262	332	382	452	526	602	332	372	432	492	552	642	732

IAC Model	W/In H/In	36	36	36	36	36	36	36	48	48	48	48	48	48	48
3ELBM-S	Wt/lb.	N/A	N/A	N/A	N/A	N/A	N/A	N/A	N/A	N/A	N/A	N/A	N/A	N/A	N/A
5ELBM-S		167	237	277	312	352	427	477	218	252	332	412	492	572	652
7ELBM-S		229	327	383	432	488	593	663	300.4	348	460	572	684	796	908
10ELBM-S		322	462	542	612	692	842	942	424	492	652	812	972	1132	1292

Table III: Aerodynamic Performance

IAC Model	L/Ft	Static Pressure Drop, i.w.g.															
		ELBM-S	3'	0.02	0.03	0.04	0.06	0.07	0.09	0.11	0.13	0.15	0.18	0.20	0.23	0.26	0.29
5'	0.02		0.03	0.04	0.06	0.07	0.09	0.11	0.13	0.15	0.18	0.20	0.23	0.26	0.29	0.33	0.36
7'	0.02		0.03	0.04	0.06	0.07	0.09	0.11	0.13	0.15	0.18	0.20	0.23	0.26	0.29	0.33	0.36
10'	0.02		0.03	0.04	0.06	0.07	0.09	0.11	0.13	0.15	0.18	0.20	0.23	0.26	0.29	0.33	0.36
Silencer Face Velocity, fpm		250	300	350	400	450	500	550	600	650	700	750	800	850	900	950	1000

Table IV: Self-Noise Power Levels, dB re: 10-12 Watts

IAC Model	Octave Band	1	2	3	4	5	6	7	8
	Hz	63	125	250	500	1K	2K	4K	8K
	Silencer Face Velocity, fpm								
ELBM-S	-2000	74	75	71	76	68	70	70	69
	-1000	67	70	65	70	62	64	63	62
	0	68	73	66	69	66	68	63	57
	1000	68	76	67	67	69	72	63	51
	2000	75	81	72	75	76	77	72	60

(+) Forward Flow / (-) Reverse Flow. Aero-acoustic performance data based on NVLAP accredited laboratory tests conducted in strict accordance with ASTM E477-99.

TAKE NOTE!

- Silencer Face Area is the cross-sectional area at the silencer entrance
- Face Velocity is the CFM of airflow divided by the Face Area (in sq. ft.)
- Pressure Drop for any velocity can be calculated from this equation:
 $PD = (Actual\ FV/Catalog\ FV)^2 \times (Catalog\ PD)$
- Self Noise values shown are for a four-square-foot face area silencer
- For each doubling of the face area add 3 dB to the self-noise values listed
- For each halving of the face area subtract 3 dB from the self-noise values listed
- Weights and measures are listed for limited number of available sizes

Quiet-Elbow™ Silencers

Type: ELBM-ES

Forward & Reverse Flow Ratings

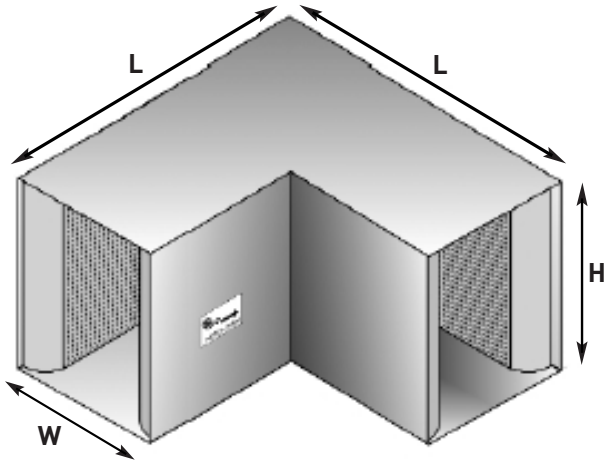

IAC Type ELBM Modular Elbows are designed to fit where shorter type of duct runs do not allow for standard type rectangular silencers. ELBM elbows also add the benefit of improved mid-range frequency performance while keeping the pressure drop minimal. ELBM's can come as standard with fiberglass infill with the same characteristics of our Quiet-Duct Commercial Series; they can also come as 100% Environmental friendly having the same characteristics of our Quiet-Duct Ultra/Green Series and they can also come with our "Hospital Grade" type characteristics, as with our Quiet-Duct Clean-Flow Series.

Designating Silencers

Model: 5ELBM 24 x 18

Type: ELBM **Length:** 5' **Width:** 24" **Height:** 18"

Pressure Loss for ELBM silencers is 0.2" at 1000 fpm

Table I: Dynamic Insertion Loss (DIL) Ratings: Forward (+) / Reverse (-) Flow

IAC Model	Octave Band	1	2	3	4	5	6	7	8
	Hz	63	125	250	500	1K	2K	4K	8K
	Face Velocity, fpm	Dynamic Insertion Loss, dB							
3ELBM-ES	-2000	4	8	16	31	39	39	29	22
	-1000	4	8	16	31	39	39	29	22
	0	4	8	16	31	39	39	29	22
	1000	4	8	16	31	39	39	29	22
	2000	4	8	16	31	39	39	29	22
5ELBM-ES	-2000	8	13	21	41	55	54	41	29
	-1000	8	13	21	41	55	54	41	29
	0	8	13	21	41	55	54	41	29
	1000	8	13	21	41	55	54	41	29
	2000	8	13	21	41	55	54	41	29
7ELBM-ES	-2000	8	18	36	54	59	58	51	37
	-1000	8	18	36	54	59	58	51	37
	0	8	18	36	54	59	58	51	37
	1000	8	18	36	54	59	58	51	37
	2000	8	18	36	54	59	58	51	37
10ELBM-ES	-2000	10	26	43	61	59	62	56	43
	-1000	10	26	43	61	59	62	56	43
	0	10	26	43	61	59	62	56	43
	1000	10	26	43	61	59	62	56	43
	2000	10	26	43	61	59	62	56	43

(+) Forward Flow / (-) Reverse Flow. Aero-acoustic performance data based on NVLAP accredited laboratory tests conducted in strict accordance with ASTM E477-99. Contact IAC if attenuation in excess of 50 dB is required.

Table II: Weights & Measures

IAC Model	W/In	12	12	12	12	12	12	12	24	24	24	24	24	24	24
	H/In	12	18	24	30	36	42	48	12	18	24	30	36	42	48
3ELBM-ES	Wt/lb.	94	109	129	149	169	194	224	129	144	164	184	204	234	264
5ELBM-ES		129	149	184	209	244	281	319	184	204	234	264	294	339	384
7ELBM-ES		171	199	248	283	332	383.8	437	248	276	318	360	402	465	528
10ELBM-ES		234	274	344	394	464	538	614	344	384	444	504	564	654	744

IAC Model	W/In	36	36	36	36	36	36	36	48	48	48	48	48	48	48
	H/In	12	18	24	30	36	42	48	12	18	24	30	36	42	48
3ELBM-ES	Wt/lb.	N/A	N/A	N/A	N/A	N/A	N/A	N/A	N/A	N/A	N/A	N/A	N/A	N/A	N/A
5ELBM-ES		179	249	289	324	364	439	489	230	264	344	424	504	584	664
7ELBM-ES		241	339	395	444	500	605	675	312.4	360	472	584	696	808	920
10ELBM-ES		334	474	554	624	704	854	954	436	504	664	824	984	1144	1304

Table III: Aerodynamic Performance

IAC Model	L/Ft	Static Pressure Drop, i.w.g.															
		ELBM-ES	3'	0.01	0.02	0.03	0.04	0.04	0.06	0.07	0.08	0.09	0.11	0.12	0.14	0.16	0.18
5'	0.01		0.02	0.03	0.04	0.04	0.06	0.07	0.08	0.09	0.11	0.12	0.14	0.16	0.18	0.20	0.22
7'	0.01		0.02	0.03	0.04	0.04	0.06	0.07	0.08	0.09	0.11	0.12	0.14	0.16	0.18	0.20	0.22
10'	0.01		0.02	0.03	0.04	0.04	0.06	0.07	0.08	0.09	0.11	0.12	0.14	0.16	0.18	0.20	0.22
Silencer Face Velocity, fpm		250	300	350	400	450	500	550	600	650	700	750	800	850	900	950	1000

Table IV: Self-Noise Power Levels, dB re: 10-12 Watts

IAC Model	Octave Band	1	2	3	4	5	6	7	8
	Hz	63	125	250	500	1K	2K	4K	8K
	Silencer Face Velocity, fpm								
ELBM-ES	-2000	62	67	68	70	68	71	72	67
	-1000	54	60	60	66	60	68	59	60
	0	55	61	56	59	59	62	54	51
	1000	55	62	51	52	57	56	48	41
	2000	61	69	63	61	64	67	63	54

(+) Forward Flow / (-) Reverse Flow. Aero-acoustic performance data based on NVLAP accredited laboratory tests conducted in strict accordance with ASTM E477-99.

TAKE NOTE!

- Silencer Face Area is the cross-sectional area at the silencer entrance
- Face Velocity is the CFM of airflow divided by the Face Area (in sq. ft.)
- Pressure Drop for any velocity can be calculated from this equation:
 $PD = (Actual\ FV/Catalog\ FV)^2 \times (Catalog\ PD)$
- Self Noise values shown are for a four-square-foot face area silencer
- For each doubling of the face area add 3 dB to the self-noise values listed
- For each halving of the face area subtract 3 dB from the self-noise values listed
- Weights and measures are listed for limited number of available sizes

Making the World a Quieter Place

Markets Served by IAC Acoustics



Architectural

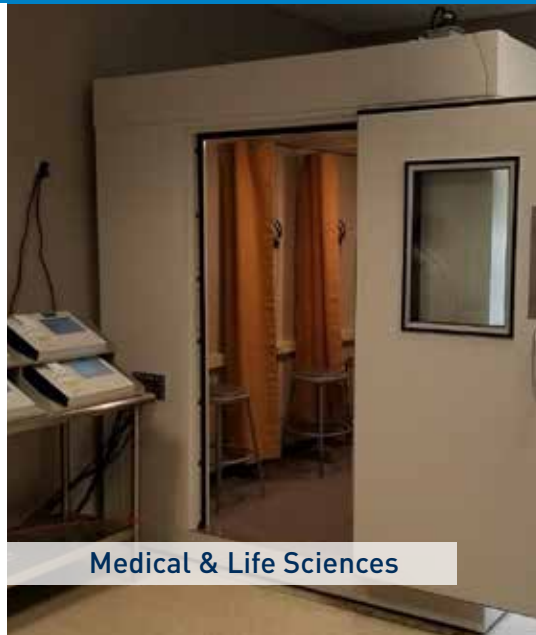

Medical & Life Sciences

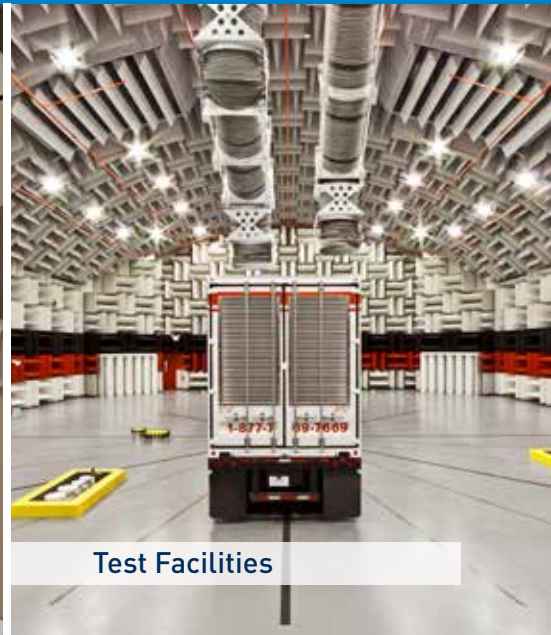

Test Facilities



Industrial



Dyno Test Rooms



HVAC