

D-Duct Diffuser / Silencer

Section 15000 Specifications

1.01 General

- A. Furnish and install "D-Duct" acoustic diffuser silencers of the types and sizes shown on the plans and/or listed in the schedule. Silencers shall be the product of IAC Acoustics. Any specification change must be submitted in writing and approved by the Architect/Engineer, in writing, at least 10 days prior to the bid due-date.

2.01 Materials

- A. Outer casings of tubular silencers shall be made of type #G-90 lock-former-quality galvanized steel in the following gauges based on the smallest diameter of the internal diffuser cone:

Cone Diameter, In. Up to 35.5	Metal Gauge 22	Cone Diameter, In. Up to 35.5	Metal Gauge 22
>36	18	38-60	18

- B. Diffuser silencers shall include an internal core of consistent diameter along the entire length in the direction of airflow. The core diameter shall be selected based on the adjacent hub diameter or, in the case of C-frame mounted motors, the motor frame size for the respective fan system on which the diffuser silencer is installed.
- C. The internal core shall be constructed from lock-former-quality type G-90 galvanized perforated steel in the same gauge as the internal diffuser cone. The core shall be supported by a minimum of three (3) welded radial attachment brackets installed at 120 degree angles to each other to provide uniform support.
- D. Combustion ratings for the silencer acoustic fill shall be not greater than the following when tested to ASTM E 84, NFPA Standard 255, or UL No. 723:

Flamespread Classification	20
Smoke Development Rating.....	20

3.01 Construction

- A. Four inch long, 11 gauge, sleeved end connections shall be provided as standard. When noted, rolled angle flanges shall be factory welded to the sleeve.
- B. For units where the minimum diffuser cone diameter is 36" or greater, an additional support rod shall be welded between the radial bracket and the sleeve to prevent a twist from being exerted on the internal core by the fan's air flow.
- C. All welds shall be touched-up with zinc-rich paint after fabrication by the manufacturer.
- D. The internal core and the rectangular outer jacket of the Diffuser Silencers shall be filled with glass fiber of a density sufficient to obtain the specified acoustic performance. The fill shall be packed under not less

than 5% compression to eliminate voids due to vibration or settling. The fill material shall be inert, vermin- and moisture-proof.

4.01 Acoustic Performance

- A. All silencer ratings shall be determined in a duct-to-reverberant room test facility which provides for airflow in both directions through the test silencer in accordance with ASTM Specification E477-99. The test facility shall be NVLAP accredited for the ASTM E477-99 test standard. Data from a non-accredited laboratory will not be acceptable. The test set-up and procedure shall be such that all effects due to end reflection, directivity, flanking transmission, standing waves and test chamber sound absorption are eliminated.

Acoustic ratings shall include Dynamic Insertion Loss (DIL) and Self-Noise (SN) Power Levels both for FORWARD FLOW (air and noise in same direction) and REVERSE FLOW (air and noise in opposite directions) with airflow of at least 2000 fpm entering face velocity.

5.01 Aerodynamic Performance

- A. Diffuser Silencers shall function as pressure regain devices to minimize system pressure losses at the fan. Fan selections are based on the regain performance of the Diffuser Silencer configurations specified. Any deviations in configuration which adversely affect the fan performance efficiency will not be accepted.
- B. Silencers shall not fail structurally when exposed to a differential air pressure of 8 inches water gauge inside to outside the casing.

6.01 Certification

- A. With submittals, the manufacturer shall supply certified test data on Dynamic Insertion Loss, Self-Noise Power Levels, and Aerodynamic Performance for Reverse and Forward Flow test conditions. Test data shall be for a standard product. All rating tests shall be conducted in the same facility, shall utilize the same silencer, and shall be open to inspection upon request from the Architect/Engineer.

7.01 Duct Transitions

- A. When transitions are required to adapt silencer dimensions to connecting duct work they shall be furnished by the installing contractor.

D-Duct Diffuser / Silencer

Type: DDS

Forward & Reverse Flow Ratings

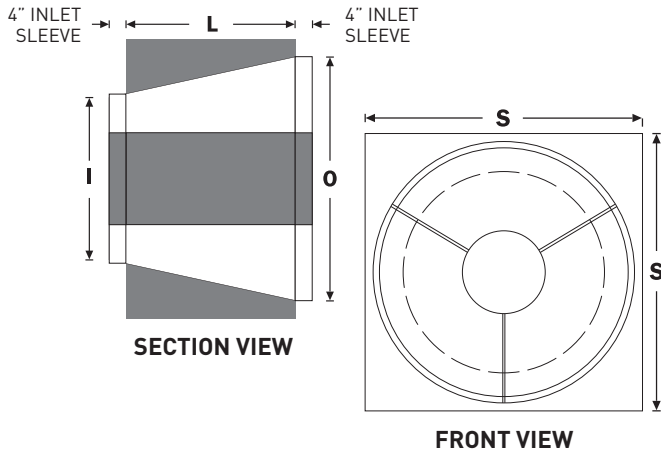

The IAC D-Duct (DDS) Diffuser/Silencer is designed for installation at the outlet of a vane axial fans. Available in sizes matched directly to manufacturer's fan sizes, it has excellent acoustic performance. At the same time it reduces system pressure drop and can be used as an effective inlet cone and silencer. The combined interior diffuser cone and exterior square jacket casing makes these units excellent when requiring aerodynamic-regain devices as well as silencers.

Overall, the IAC D-Duct Diffusers/Silencers have been completely engineered to provide noise attenuation directly at the source, improving fan aerodynamic performance for the inlet and discharge. All D-Duct Diffusers/Silencers have been rated with procedures certified in strict accordance with ASTM E477-99 in a NVLAP Accredited Acoustical Laboratory.

Physical Data

IAC Model	I Inlet Diameter (in)	O Outlet Diameter (in)	S (in)	L (in)	Weight (lb)
18-A	18.5	24	28	20.0	125
20-A	20.5	28	32	20.0	140
24-A	24.5	30	34	24.0	165
24-B	24.5	30	34	24.0	180
30-A	30.5	40	44	30.0	225
30-B	30.5	40	44	30.0	240
30-C	30.5	40	44	30.0	260
36-A	36.5	46	50	37.75	290
36-B	36.5	46	50	37.75	300
36-C	36.5	46	50	37.75	310
36-D	36.5	46	50	37.75	325
42-A	42.5	52	56	36.0	400
42-B	42.5	52	56	36.0	410
42-C	42.5	52	56	36.0	430
48-A	48.5	60	64	43.5	550
48-B	48.5	60	64	43.5	580
48-C	48.5	60	64	43.5	610
54-A	55.25	68	72	48.0	700
54-B	55.25	68	72	48.0	750
54-C	55.25	68	72	48.0	790
60-A	61.0	74	78	52.75	750
60-B	61.0	74	78	52.75	790
66-A	67.0	82	86	58.5	1190
66-B	67.0	82	86	58.5	1250
70-A	73.0	90	94	68.0	1400
70-B	73.0	90	94	68.0	1500

Dynamic Insertion Loss (DIL) Ratings (dB):

IAC Model	Octave Band	1	2	3	4	5	6	7	8
	Hz	63	125	250	500	1K	2K	4K	8K
18-A	-	-	3	13	22	27	23	17	13
20-A	-	-	2	12	20	26	22	16	12
24-A	1	4	14	20	24	20	15	12	
24-B	1	5	15	20	25	21	15	12	
30-A	1	7	15	19	21	17	14	12	
30-B	1	8	15	19	21	17	14	12	
30-C	2	8	15	19	21	18	14	12	
36-A	2	8	15	18	17	13	12	11	
36-B	2	9	15	18	17	13	11	10	
36-C	2	9	15	18	18	14	11	10	
36-D	2	9	16	18	19	14	11	10	
42-A	3	10	16	17	16	12	10	9	
42-B	3	10	16	17	16	12	11	10	
42-C	3	10	16	18	16	13	11	10	
48-A	3	11	17	18	16	12	10	10	
48-B	3	11	17	18	16	12	11	10	
48-C	3	11	18	19	17	13	12	10	
54-A	3	11	17	18	16	12	10	10	
54-B	3	11	17	18	16	12	11	10	
54-C	3	11	17	19	17	12	12	10	
60-A	4	12	18	19	14	10	10	10	
60-B	4	12	18	20	16	12	11	10	
66-A	4	12	18	19	14	10	10	10	
66-B	4	12	18	20	16	12	11	10	
70-A	4	12	17	16	12	10	10	10	
70-B	4	12	18	18	15	10	10	10	

Custom sizes are available. Please contact IAC Acoustics representative for details.

(+) Forward Flow / (-) Reverse Flow. Aero-acoustic performance data based on NVLAP accredited laboratory tests conducted in strict accordance with ASTM E477-99. Contact IAC if attenuation in excess of 50 dB is required.

Ducted Discharge

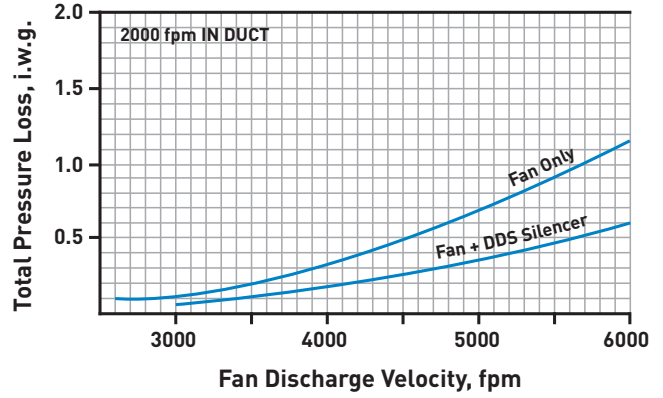
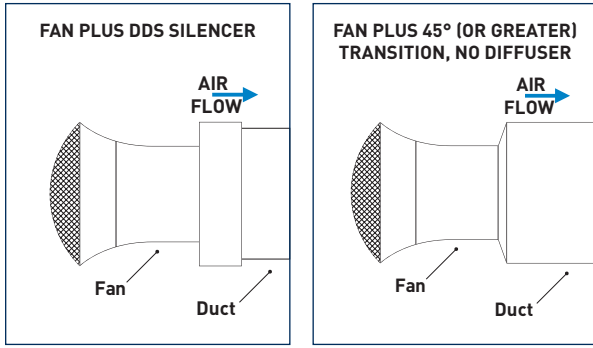

Discharge Into Low Velocity Plenums

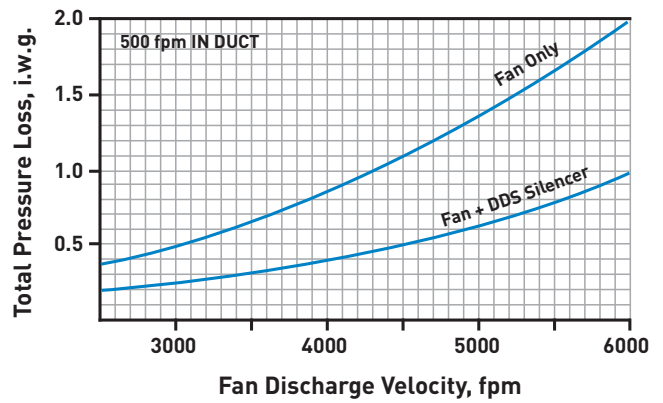
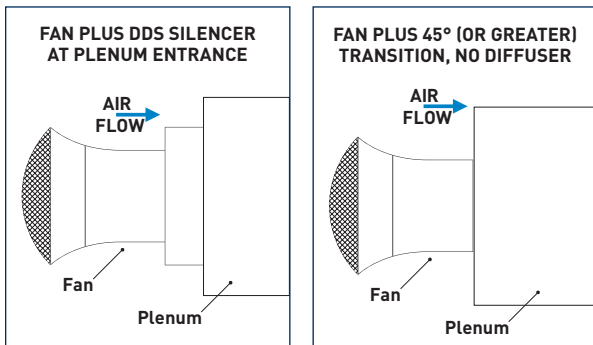

Free Discharge

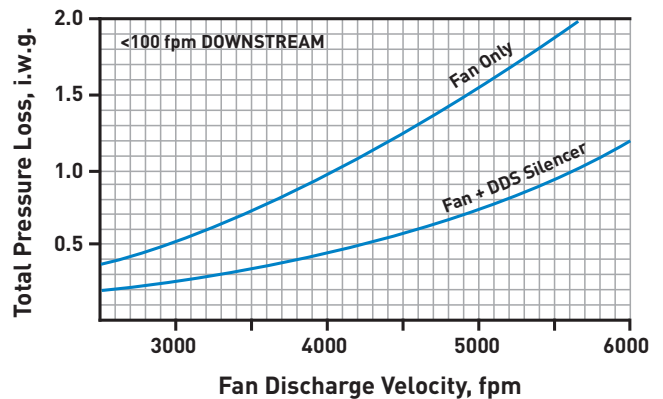
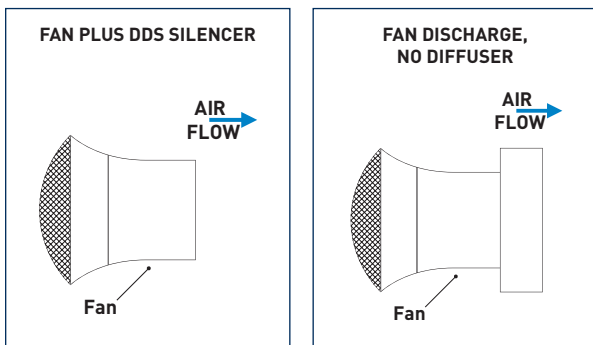

(+) Forward Flow / (-) Reverse Flow. Aero-acoustic performance data based on NVLAP accredited laboratory tests conducted in strict accordance with ASTM E477-99. Contact IAC if attenuation in excess of 50 dB is required.